

5 Port Solenoid Valve Metal Seal/Rubber Seal Base Mounted Series VQ5000

Space-saving profile

Clean space saving design with all pilot valves concentrated to one side with no protrusions in any direction

Space-saving — 40% less
Capacity-saving — 50% less
(In-house comparison)

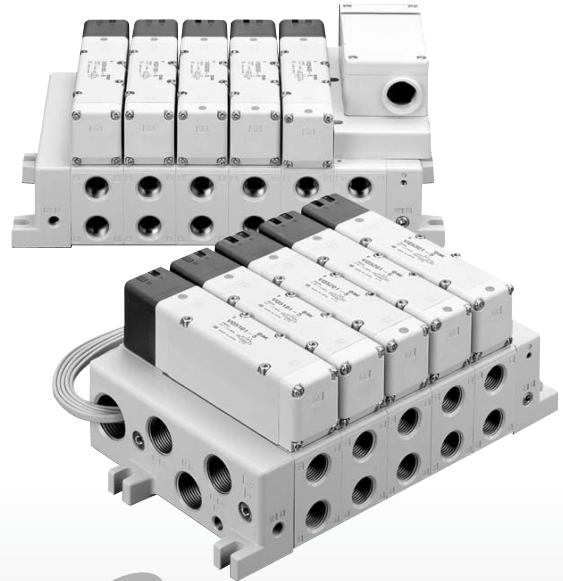

- VQC
- SQ
- VQ0
- VQ4
- VQ5**
- VQZ
- VQD

Compact with large flow capacity

(Ideal for driving cylinders up to $\phi 180$)

Outstanding response times and long service life

(Metal seal with light/surge suppressor)

VQ5100 (Single)	32 mS	100 million cycles * According to SMC life test conditions
VQ5200 (Double)	17 mS	
Accuracy	± 3 mS	

* For applications which demand high speed, high frequency, long life and a precise response time.

Enclosure IP65 compliant Dust tight/Low jetproof type

A variety of common wiring methods are standardized.

<Plug-in type>

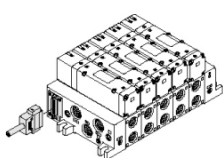
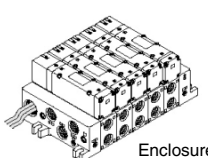
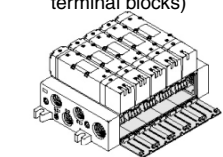
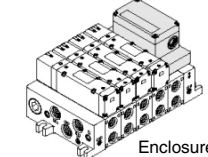
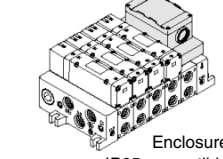
F kit (D-sub connector) 	L kit (Lead wire) 
T1 kit (With individual terminal blocks) 	S kit (Serial transmission) 
T kit (Terminal block box) 	<ul style="list-style-type: none"> 5 wiring types have been standardized to facilitate easy wiring work and maintenance. In addition, 3 of the wiring types are available with IP65 enclosures.

Cylinder Speed Chart

Use as a guide for selection. Please confirm the actual conditions with SMC Sizing Program.

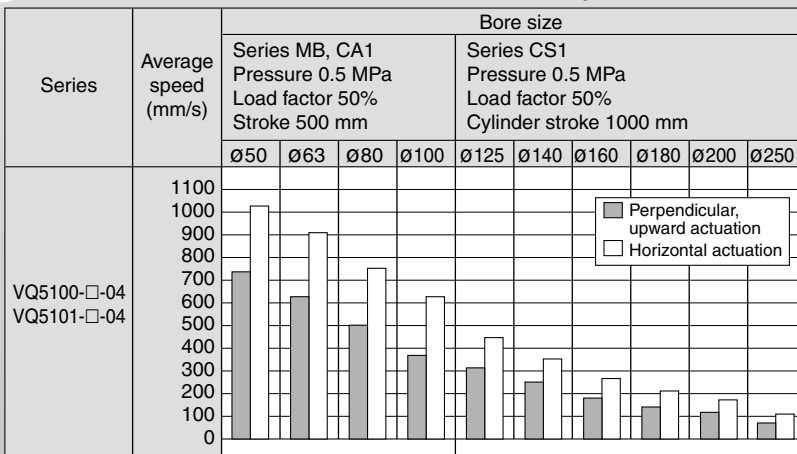

- * It is when the cylinder is extending that is meter-out controlled by speed controller which is directly connected with cylinder, and its needle valve with being fully open.
- * The average velocity of the cylinder is what the stroke is divided by the total stroke time.
- * Load factor: $((\text{Load weight} \times 9.8) / \text{Theoretical force}) \times 100\%$

System Components

Speed controller	Silencer	SGP (Steel pipe) dia. x Length
AS420-04	AN400-04	10A x 1 m

Individual wiring type

<Plug lead type>

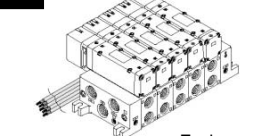
C kit (Connector) 
--

Grommet type
Enclosure IP65 compatible

Series VQ5000

⚠ Precautions

Be sure to read before handling. For Safety Instructions and Solenoid Valve Precautions, refer to page 2-9-2.

Manual Override Operation

⚠ Warning

Since connected equipment will be actuated when the manual override is operated, first confirm that conditions are safe.

Non-locking push type (Tool required) is standard. As an option, slotted locking type (Tool required) is available.

Push type (Tool required)

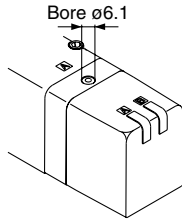

Push down the manual override button with a small screwdriver, etc.
Release the screwdriver and the manual override will return.

Locking type (Option)

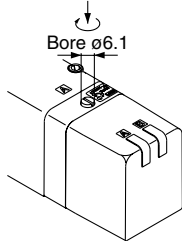

Push down completely on the manual override button with a small screwdriver. While down, turn clockwise 90° to lock it. Turn it counterclockwise to release it.

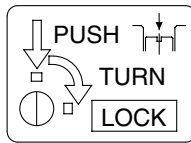

Mounting of Valves

⚠ Caution

After confirming the gasket is correctly placed under the valve, securely tighten the bolts with the proper torque shown in the table below.

Proper tightening torque (N·m)
1 to 1.8

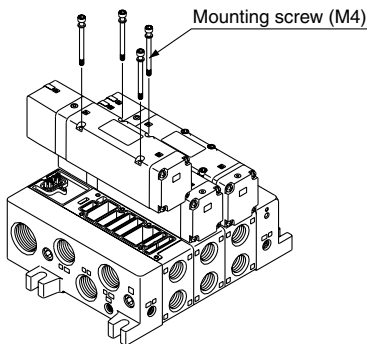

Lead Wire Connection

⚠ Caution

Plug-in sub-plate (With terminal block)

- If the junction cover (1) of the sub-plate is removed, you can see the plug-in type terminal block (2) mounted inside the sub-plate.

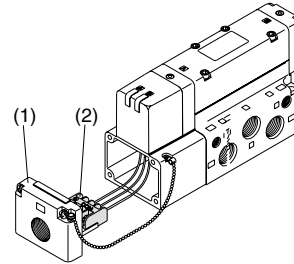

- The terminal block is marked as follows. Connect wiring to each of the power supply terminals.

Terminal block marking	A	COM	B	T
Model				
VQ510₁⁰	A side	COM	—	—
VQ520₁⁰	A side	COM	B side	—
VQ5₃⁴0₆⁰	A side	COM	B side	—

Note 1) There is no polarity. It can also be used as -COM.
Note 2) The sub-plate is double wired even for the VQ510₁⁰.

- Applicable terminal 1.25-3s, 1.25Y-3, 1.25Y-3N, 1.25Y-3.5.

Plug lead: Grommet type

Make connections to each corresponding wire.

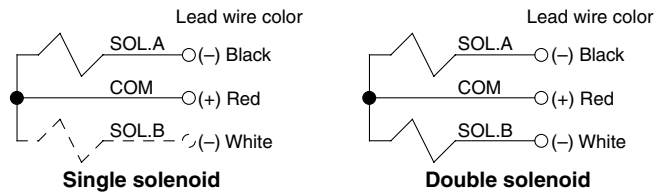

	Single solenoid	Double solenoid
Standard	Black: A side solenoid (-) Red: COM (+)	Black: A side solenoid (-) Red: COM (+) White: B side solenoid (-)
Enclosure IP65 compliant	Black: A side solenoid (-) Red: COM (+) White: B side solenoid (-) (Not used for single solenoid) Green: (Not used for single or double.)	

Note) There is no polarity. It can also be used as -COM.

- VQC
- SQ
- VQ0
- VQ4
- VQ5
- VQZ
- VQD

Installation and Removal of Light Cover

⚠ Caution

Installation/Removal of light cover

● **Removal**

To remove the pilot cover pull it straight off. If it is pulled off at an angle, the pilot valve may be damaged or the protective O-ring may be scratched.

● **Installation**

Place the cover straight over the pilot assembly so that the pilot valve is not touched, and push it until the cover hook locks without twisting the protective O-ring. (When pushed in, the hook opens and locks automatically.)

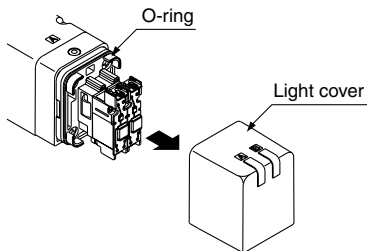

Replacement of Pilot Valve

⚠ Caution

● **Removal**

1. Remove the mounting screw that holds the pilot valve using a small screwdriver.
2. When equipped with light, remove the light circuit board which is installed on the pilot valve by pulling it straight off the connector pins.

● **Installation**

1. Insert the light circuit board straight onto the connector pins following the guide. If it is pushed in forcibly without following the guide, there is a danger of possibly bending the board contacts.
2. After confirming the gasket is correctly placed under the valve, securely tighten the bolts with the proper torque shown in the table below.

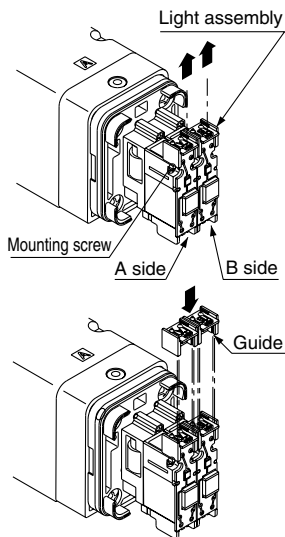

Proper tightening torque (N·m)
0.1 to 0.13

Note) The mounting of pilot valves is not directional with respect to the A and B sides. However, the light circuit boards' A side is orange and the B side is green. It must be mounted on the pilot valve in accordance with the mounting indicators. The light will not go on if the mounting is reversed.

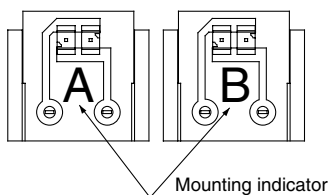

Light Circuit Board Part No.

SOL.A	VQZ100-47-A
SOL.B	VQZ100-47-B

Note) It can be used with all voltages.

For Plug Lead Type

Attaching and detaching connectors

- To attach a connector, hold the lever and connector unit between your fingers and insert straight onto the pins of the solenoid valve so that the lever's pawl is pushed into the groove and locks.
- To detach a connector, remove the pawl from the groove by pushing the lever downward with your thumb, and pull the connector straight out.

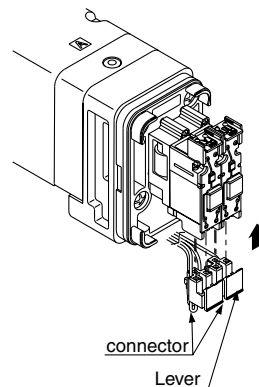

Note) Do not pull on the lead wires with excessive force. This can cause faulty and/or broken contacts.

Internal Wiring Specifications

⚠ Caution

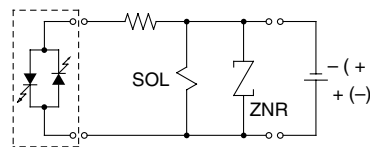

Light circuit assembly (Orange)

DC: Single

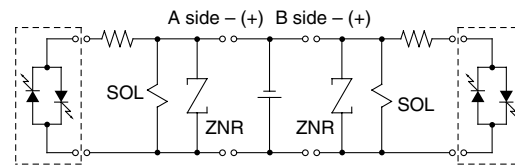

A side light circuit assembly (Orange)

DC: Double

B side light circuit assembly (Green)

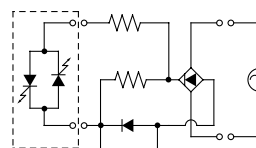

Light circuit assembly (Orange)

AC: Single

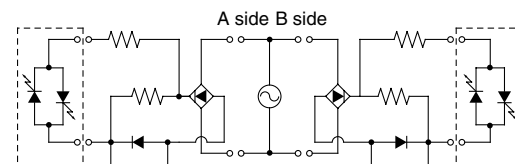

A side light circuit assembly (Orange)

AC: Double

B side light circuit assembly (Green)

How to Calculate the Flow Rate

For obtaining the flow rate, refer to pages 2-1-8 to 2-1-11.

Series VQ5000

Base Mounted

Plug-in/Plug Lead: Single Unit

Model

Series	Number of solenoids		Model		Port size	Flow Characteristics						Response time (ms)			Weight (kg)
						1 → 4/2 (P → A/B)			4/2 → 5/3 (A/B → EA/EB)			Standard 1 W	Low wattage 0.5 W	AC	
						C _d (dm ³ /(s·bar))	b	C _v	C _d (dm ³ /(s·bar))	b	C _v				
VQ5000	2 position	Single	Metal seal	VQ51 ₅ 0	Rc 1/2	12	0.14	2.9	14	0.18	3.4	35 or less	38 or less	38 or less	0.59 (0.67)
			Rubber seal	VQ51 ₅ 1		16	0.33	4.4	17	0.31	4.7	40 or less	43 or less	43 or less	0.58 (0.66)
		Double	Metal seal	VQ52 ₅ 0		12	0.14	2.9	14	0.18	3.4	20 or less	23 or less	23 or less	0.62 (0.70)
			Rubber seal	VQ52 ₅ 1		16	0.33	4.4	17	0.31	4.7	25 or less	28 or less	28 or less	0.60 (0.68)
	3 position	Closed center	Metal seal	VQ53 ₅ 0		11	0.24	2.6	11	0.23	2.8	50 or less	53 or less	53 or less	0.65 (0.73)
			Rubber seal	VQ53 ₅ 1		12	0.33	3.4	13	0.37	3.7	60 or less	63 or less	63 or less	0.58 (0.66)
		Exhaust center	Metal seal	VQ54 ₅ 0		12	0.13	2.9	14	0.18	3.4	50 or less	53 or less	53 or less	0.65 (0.73)
			Rubber seal	VQ54 ₅ 1		14	0.39	3.9	16	0.35	4.5	60 or less	63 or less	63 or less	0.58 (0.66)
		Pressure center	Metal seal	VQ55 ₅ 0		12	0.23	2.9	13	0.24	3.3	50 or less	53 or less	53 or less	0.65 (0.73)
			Rubber seal	VQ55 ₅ 1		13	0.32	3.4	14	0.40	3.9	60 or less	63 or less	63 or less	0.58 (0.66)
		Double check	Metal seal	VQ56 ₅ 0		8.0	—	—	8.5	—	—	62 or less	65 or less	65 or less	1.17 (1.25)
			Rubber seal	VQ56 ₅ 1		8.3	—	—	9.0	—	—	75 or less	78 or less	78 or less	1.10 (1.18)

Note) Value for valve on sub-plate.



JIS Symbol

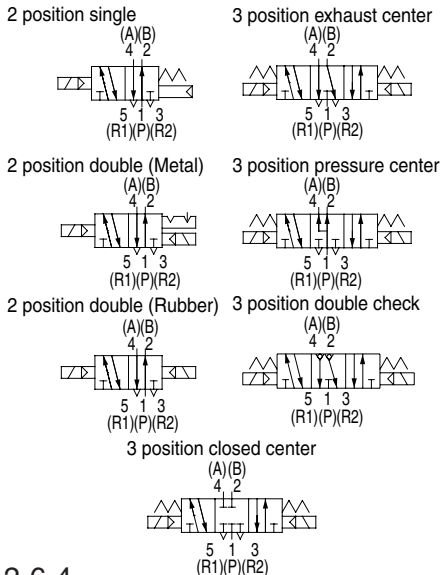

Standard Specifications

Valve specifications	Valve construction		Metal seal	Rubber seal
	Fluid		Air/Inert gas	
	Maximum operating pressure ⁽³⁾		1.0 MPa	
	Min. operating pressure	Single	0.10 MPa	0.20 MPa
		Double	0.10 MPa	0.15 MPa
		3 position	0.15 MPa	0.20 MPa
	Proof pressure		1.5 MPa	
	Ambient and fluid temperature		-5 to 50°C ⁽¹⁾	
	Lubrication		Not required	
	Manual override		Push type/Locking type (Tool required) Option	
Shock/Vibration resistance		150/30 m/s ² ⁽²⁾		
Protection structure		Dust tight (IP65 compatible)		
Solenoid specifications	Coil rated voltage		12, 24 VDC, 100, 110, 200, 220 VAC (50/60 Hz)	
	Allowable voltage fluctuation		±10% of rated voltage	
	Coil insulation type		Class B or equivalent	
	Power consumption (Current)	24 VDC	1 W DC (42 mA), 0.5 W DC (21 mA) ⁽³⁾	
		12 VDC	1 W DC (83 mA), 0.5 W DC (42 mA) Note ⁽³⁾	
100 VAC		Inrush 1.2 VA (12 mA), Holding 1.2 VA (12 mA)		
110 VAC		Inrush 1.3 VA (11.7 mA), Holding 1.3 VA (11.7 mA)		
200 VAC	Inrush 2.4 VA (12 mA), Holding 2.4 VA (12 mA)			
220 VAC	Inrush 2.6 VA (11.7 mA), Holding 2.6 VA (11.7 mA)			



Note 1) Use dry air to prevent condensation when operating at low temperatures.

Note 2) Impact resistance: No malfunction occurred when it is tested with a drop tester in the axial direction and at the right angles to the main valve and armature in both energized and de-energized states every once for each condition. (Values at the initial period)

Vibration resistance: No malfunction occurred in a one-sweep test between 45 and 2000 Hz. Test was performed at both energized and de-energized states in the axial direction and at the right angles to the main valve and armature. (Values at the initial period)

Note 3) Values inside () denote the low wattage (0.5 W) specifications.

Plug-in/Plug Lead: Single Unit Series VQ5000

How to Order Valves

Body

0: Plug-in sub-plate

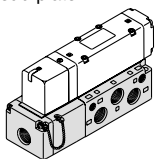

Plug-in VQ5 1 0 0 [] 5

Plug lead VQ5 2 5 1 [] 5 G

Porting specifications

Nil	Side ported
B	Bottom ported

Port size

Nil	Without sub-plate (For manifold)
04	Rc 1/2

Note) For thread standard, refer to page 2-6-39.

Type of actuation

1	2 position single (A)(B) 4 2 5 1 3 (R1) (P)(R2)	3	3 position closed center (A) (B) 4 2 5 1 3 (R1) (P)(R2)
	2 position double (A) (B) 4 2 5 1 3 (R1) (P)(R2)		3 position exhaust center (A) (B) 4 2 5 1 3 (R1) (P)(R2)
2	Metal: 2 position double (A) (B) 4 2 5 1 3 (R1) (P)(R2)	4	3 position pressure center (A) (B) 4 2 5 1 3 (R1) (P)(R2)
	Rubber: 2 position double (A) (B) 4 2 5 1 3 (R1) (P)(R2)		3 position double check (A) (B) 4 2 5 1 3 (R1) (P)(R2)

Note) For details about the double check type, refer to page 2-6-36.

Enclosure

Nil	Dust-protected
W	Dusttight/Low jetproof type (IP65)

Manual override

Nil: Non-locking push type (Tool required) Bore ø6.1	B: Slotted locking type (Tool required) Bore ø6.1
---	--

Light/Surge voltage suppressor

Nil	Yes
E	Without light, With surge voltage suppressor

Electrical entry

Grommet	G	Lead wire length 0.6 m
	H	Lead wire length 1.5 m

Coil voltage

1	100 VAC (50/60 Hz)
2	200 VAC (50/60 Hz)
3	110 VAC (50/60 Hz)
4	220 VAC (50/60 Hz)
5	24 VDC
6	12 VDC

Seal

0	Metal seal
1	Rubber seal

Body

5: Plug lead sub-plate

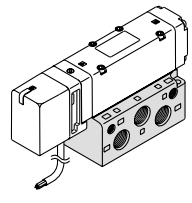

- VQC
- SQ
- VQ0
- VQ4
- VQ5**
- VQZ
- VQD

How to Order Sub-plates

VQ5000 - P [] [] 04

Electrical entry

P	Plug-in conduit terminal
S	Plug lead

Porting specifications

Nil	Side ported
B	Bottom ported

Note1) For bottom ported, port size is Rc 1/2.
Note2) For thread standard, refer to page 2-6-39.

Port size

04	Rc 1/2
----	--------

Enclosure

Nil	Dust-protected
W Note)	Dusttight/Low jetproof type

Note) Not required for plug lead type.

Note 1) Applicable to DC specifications.
Note 2) For details about external pilot specifications, refer to page 2-6-39.
Note 3) When two or more symbols are specified, indicate them alphabetically.

Replacement of pilot valve assembly (Voltage)

- Refer to pages 2-6-40 to 2-6-41 for pilot valve assembly part numbers.
- Refer to page 2-6-3 for replacement method.

Series VQ5000

Plug-in Type

Conduit terminal

2 position single: VQ510^Q

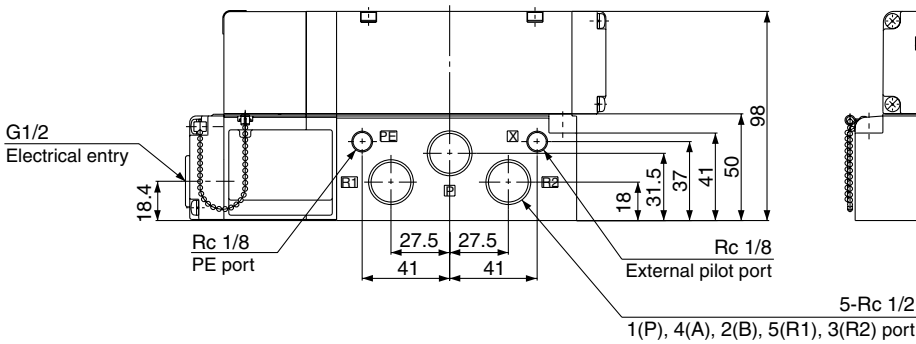
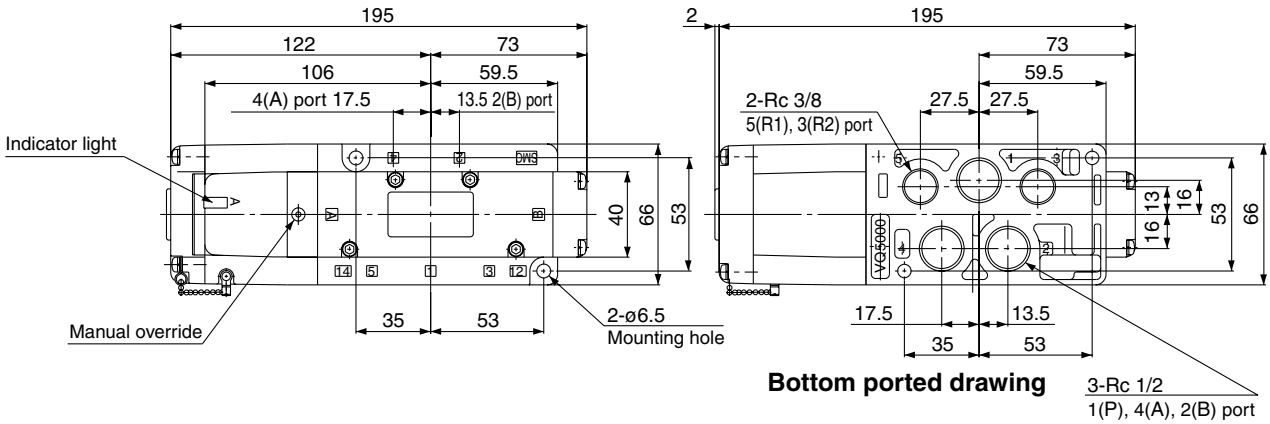

2 position double: VQ520^Q

3 position closed center: VQ530^Q

3 position exhaust center: VQ540^Q

3 position pressure center: VQ550^Q

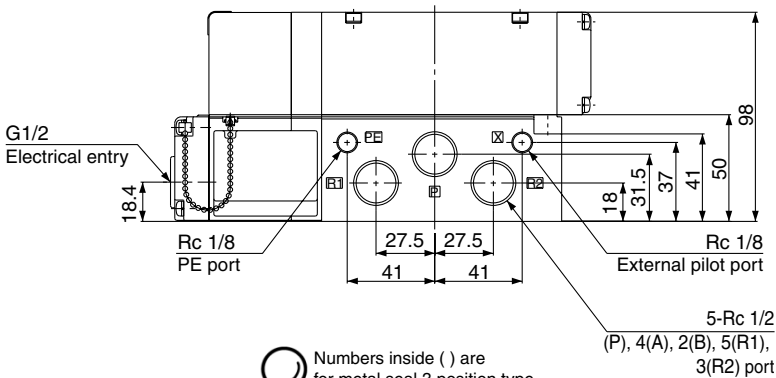
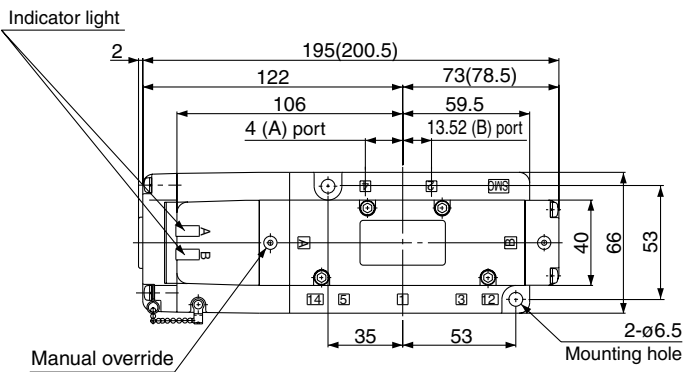

Numbers inside () are for metal seal 3 position type

3 position double check: VQ560^Q

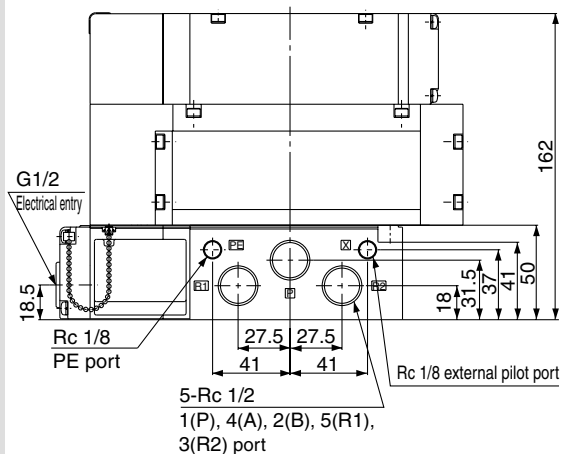
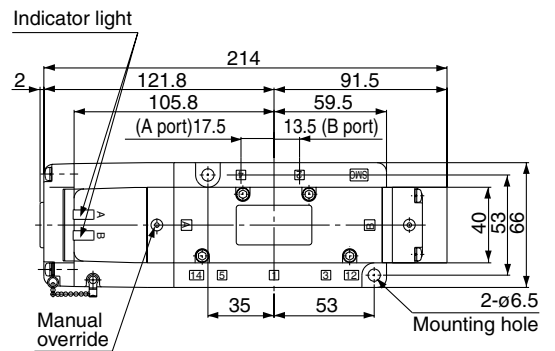

Plug-in/Plug Lead: Single Unit Series VQ5000

Plug Lead Type

Grommet

2 position single: VQ515⁰-□ $\frac{G}{H}$

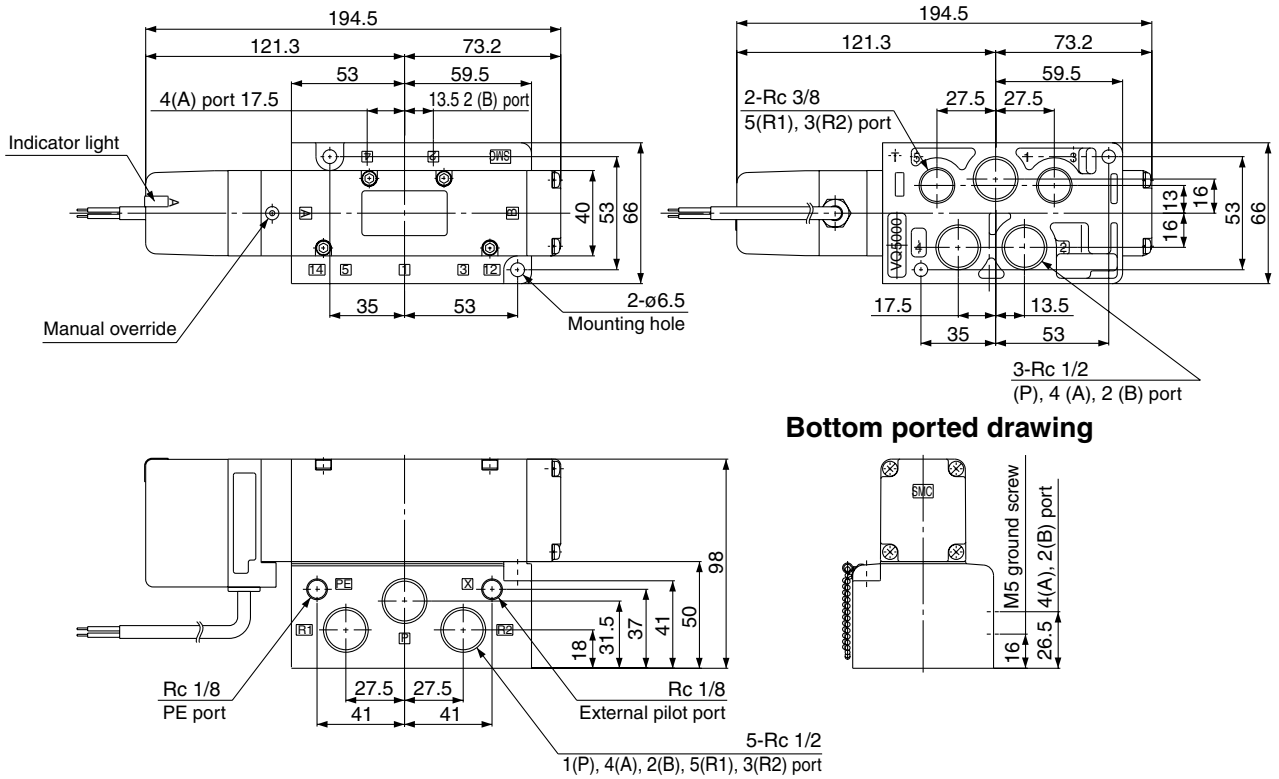

- VQC
- SQ
- VQ0
- VQ4
- VQ5**
- VQZ
- VQD

- 2 position double: VQ525⁰-□ $\frac{G}{H}$
- 3 position closed center: VQ535⁰-□ $\frac{G}{H}$
- 3 position exhaust center: VQ545⁰-□ $\frac{G}{H}$
- 3 position pressure center: VQ555⁰-□ $\frac{G}{H}$

3 position double check: VQ565⁰-□ $\frac{G}{H}$

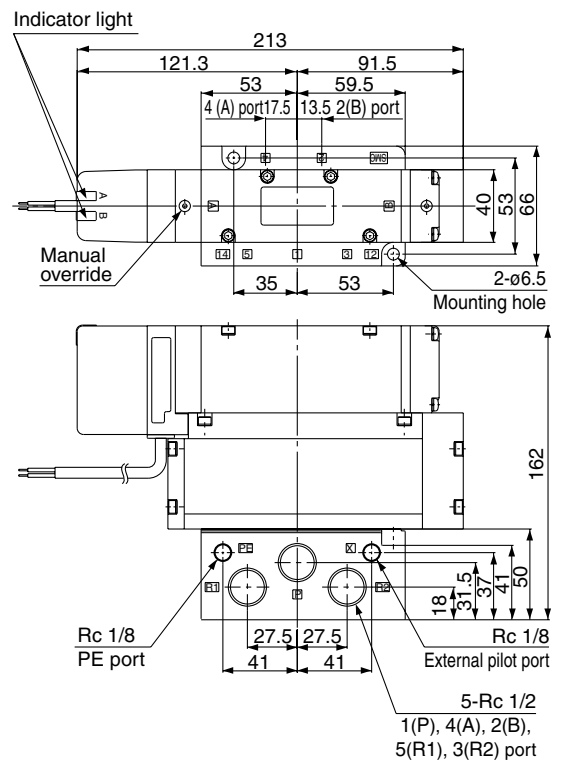
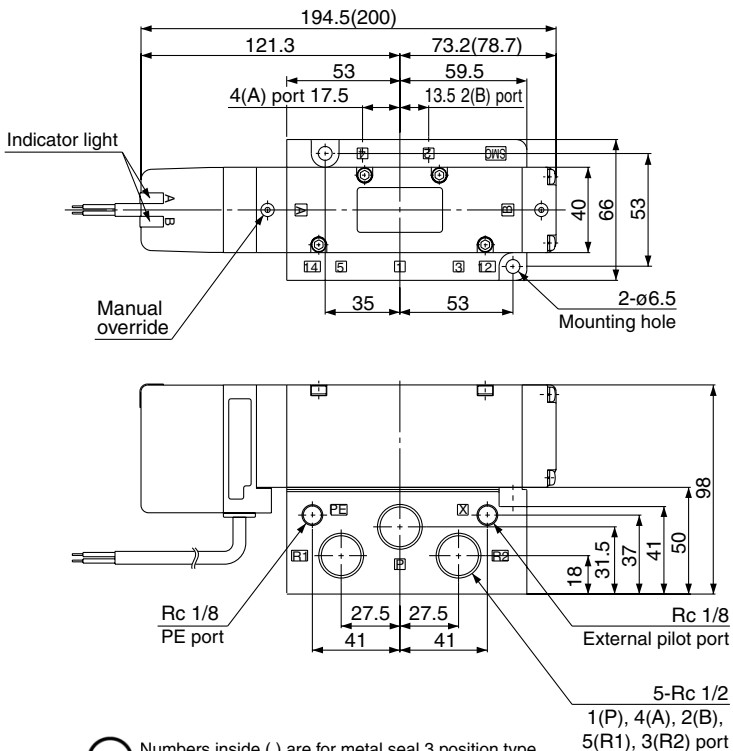

Numbers inside () are for metal seal 3 position type

Series VQ5000

Base Mounted Plug-in Unit



How to Order Manifold

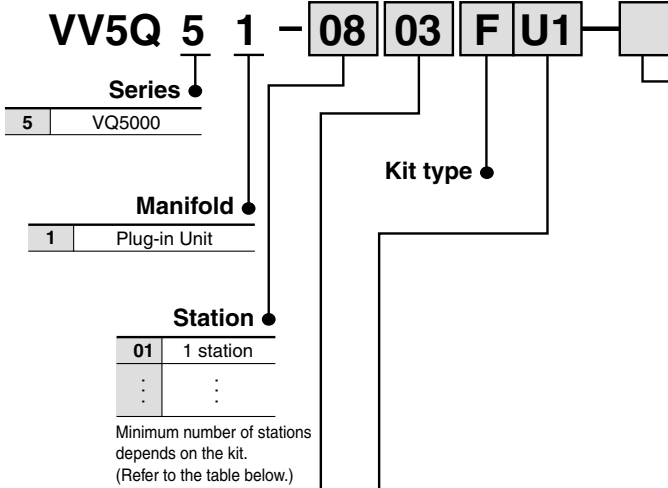

Symbol	Option
Nil	None
CD1 ⁽²⁾	Exhaust cleaner for Rc 1: D side exhaust
CD2 ⁽²⁾	Exhaust cleaner for Rc 1 1/2: D side exhaust
CU1 ⁽²⁾	Exhaust cleaner for Rc 1: U side exhaust
CU2 ⁽²⁾	Exhaust cleaner for Rc 1 1/2: U side exhaust
K ⁽⁴⁾	Special wiring specifications (Except double wiring)
N	Name plate (T kit only)
SB ⁽³⁾	Direct exhaust with silencer box: Exhaust from both D and U sides
SD ⁽²⁾	Direct exhaust with silencer box: D side exhaust
SU ⁽²⁾	Direct exhaust with silencer box: U side exhaust
W	IP65 enclosure (except F and T1 kits)

Note 1) When two or more symbols are specified, indicate them alphabetically.
Example) -CD1K

Note 2) Combination of [CU□] and [SU□] is not possible.

Note 3) Available only with F, L and T1 kits.

Note 4) Specify the wiring specifications on the manifold specification sheet. (Except L kit)

Cylinder port

03	Rc 3/8
04	Rc 1/2
B	Bottom ported Rc 1/2
CM	Mixed ^{Note)}

Note) In case of mixed specification, indicate on the manifold specification sheet.

Kit/Electrical entry/Cable length

F kit (D-sub connector)

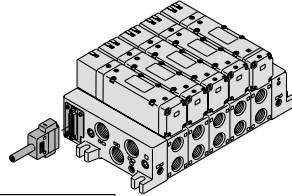

Connector entry direction				1 to 12 stations
D side	U side			
Kit D0	U0	Without cable		
Kit D1	U1	Cable length 1.5 m		
Kit D2	U2	Cable length 3 m		
Kit D3	U3	Cable length 5 m		

L kit (Lead wire cable)

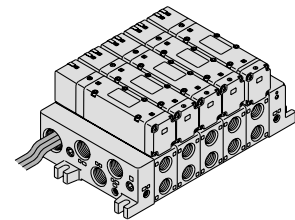

Electrical entry				1 to 12 stations
D side	U side			
Kit D0	U0	Cable length 0.6 m	IP65 compatible	
Kit D1	U1	Cable length 1.5 m		
Kit D2	U2	Cable length 3 m		

T1 kit (Individual terminal block kit)

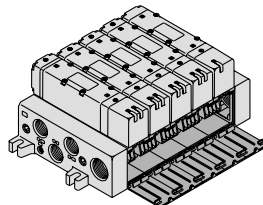

Kit T1	With terminal blocks	1 to 12 stations
--------	----------------------	------------------

T kit (Terminal block box kit)

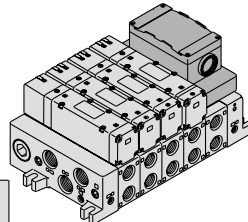

Box mounting position		IP65 compatible
D side	U side	
TD	TU	Terminal block box 2 to 12 stations

S kit (Serial transmission unit)

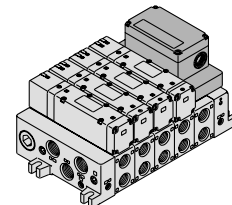

The valve voltage is 24 VDC and it is equipped with light/surge voltage suppressor.
IP65 compatible

Unit mounting position		
D side	U side	
	O	Without SI unit
	A	With general type SI unit (Series EX300)
	B	Mitsubishi Electric Corp.: MELSECNET/MINI-S3 Data Link System
	BB	Mitsubishi Electric Corp.: MELSECNET/MINI-S3 Data Link System (2 power supply systems)
	C	OMRON Corp.: SYSBUS Wire System
	D	SHARP Corp.: Satellite I/O Link System
	F1	NKE Corp.: Uni-wire System (16 output points)
	J1	SUNX Corp.: S-LINK System (16 output points)
	J2	SUNX Corp.: S-LINK System (8 output points)
	K	Fuji Electric Co.: T-LINK Mini System
	Q	DeviceNet, CompoBus/D (OMRON Corp.)
	R1	OMRON Corp.: CompoBus/S System (16 output points)
	R2	OMRON Corp.: CompoBus/S System (8 output points)
	U	JEMANET (JPCN-1)
	V	Mitsubishi Electric Corp.: CC-LINK System
	G	Rockwell Automation: Allen Bradley Remote I/O (RIO) System
	H	NKE Corp.: Uni-wire H System

2 to 12 stations

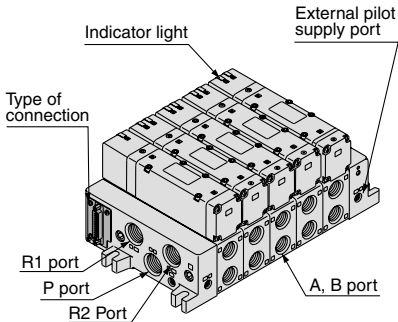

Note) The drawing shows a VV5Q51-0504FDO.

Plug-in Unit Series VQ5000

Manifold Specifications

Series	Base model	Type of connection	Porting specifications			Maximum applicable stations	Applicable solenoid valve	5 station weight (kg)
			4(A), 2(B) port location	Port size ^{Note)}				
				1(P), 5(R1), 3(R2)	4(A), 2(B)			
VQ5000	VV5Q51-□□□	<ul style="list-style-type: none"> ■ F kit—D-sub connector ■ T kit—Terminal block box ■ T1 kit—Individual terminal block kit ■ L kit—Lead wire ■ S kit—Serial transmission 	Side	Rc 3/4 Option { Direct exhaust with silencer box }	Rc 3/8 Rc 1/2	F, L, T1 kits 12 stations T kit 11 stations S kit 9 stations	VQ5L00 VQ5L01	4.1 • L kit • Not including solenoid valve weight.
			Bottom		Rc 1/2			

Note) For details about international standard threads other than Rc threads, refer to "Option" on page 2-6-39.

Flow Characteristics at the Number of Manifold Stations (Operated individually)

Model	Passage/Stations		Station 1	Station 5	Station 10
2 position metal seal VQ5 ₂ 00	1 → 4/2 (P → A/B)	C [dm ³ /(s·bar)]	11	11	11
		b	0.24	0.24	0.24
		Cv	2.7	2.7	2.7
	4/2 → 5/3 (A/B → EA/EB)	C [dm ³ /(s·bar)]	12	12	12
		b	0.14	0.14	0.14
		Cv	2.9	2.9	2.9
2 position rubber seal VQ5 ₂ 01	1 → 4/2 (P → A/B)	C [dm ³ /(s·bar)]	12	12	12
		b	0.33	0.33	0.33
		Cv	3.4	3.4	3.4
	4/2 → 5/3 (A/B → EA/EB)	C [dm ³ /(s·bar)]	16	16	16
		b	0.33	0.33	0.33
		Cv	4.4	4.4	4.4

Note) For port size Rc 1/2

Manifold Option

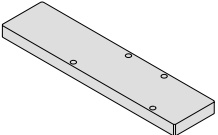
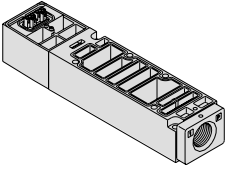
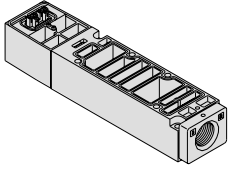
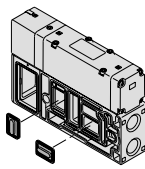
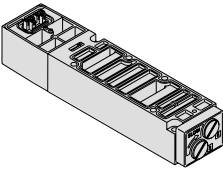
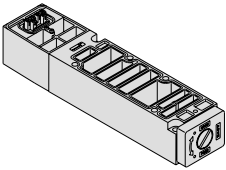
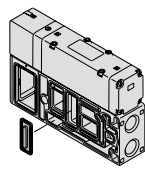
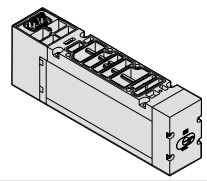
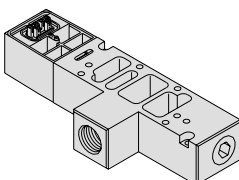
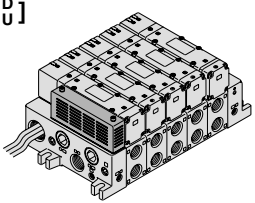
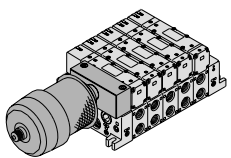
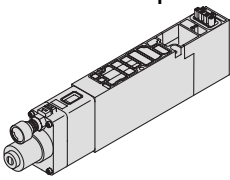
Blanking plate assembly VVQ5000-10A-1 	Individual SUP spacer VVQ5000-P-1- ⁰³ / ₀₄ 	Individual EXH spacer VVQ5000-R-1- ⁰³ / ₀₄ 	EXH block plate VVQ5000-16A-2 
Throttle valve spacer VVQ5000-20A-1 	SUP stop valve spacer VVQ5000-37A-1 	SUP block plate VVQ5000-16A-1 	Double check spacer with residual pressure release valve VVQ5000-25A-1 
Release valve spacer VVQ5000-24A-1D 	Direct exhaust with silencer box [-S _U ^D] 	For exhaust cleaner mounting [-C _U ^D □] 	Interface regulator ARBQ5000-00- ^A / _B -1 

Refer to pages 2-6-34 to 2-6-38 for detailed dimensions of each option.
For replacement parts, refer to page 2-6-43.

VQC

SQ

VQ0

VQ4

VQ5

VQZ

VQD

Series VQ5000

F Kit (D-sub Connector kit)

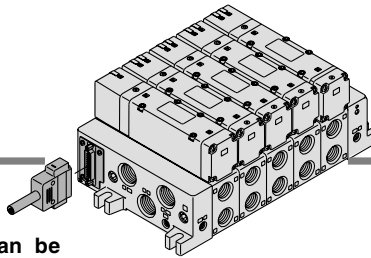

- Simplification and labor savings for wiring work can be achieved by using a D-sub connector for the electrical connection.
- Using connector for flat ribbon cable (25P) conforming to MIL standard permits the use of connectors put on the market and gives a wide interchangeability.
- Connector entry can be selected on either the U side or the D side according to the mounting orientation.
- Maximum stations are 12.

Manifold Specifications

Series	Porting specifications			Applicable stations
	4(A), 2(B) port location	Port size		
VQ5000	Side	Rc 3/4	4(A), 2(B)	Max. 12 stations
	Bottom		Rc 3/8 Rc 1/2 Rc 1/2	

D-Sub Connector Kit (25Pins)

Cable assembly ●

AXT100-DS25-015
030
050

(D-sub connector cable assemblies can be ordered with manifolds.)
Refer to How to Order Manifold.

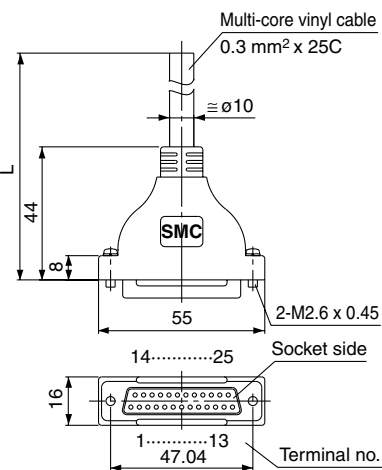

D-sub Connector Cable Assembly (Option)

Cable length (L)	Assembly part no.	Note
1.5 m	AXT100-DS25-015	Cable 25 cores x 24AWG
3 m	AXT100-DS25-030	
5 m	AXT100-DS25-050	

* For other commercial connectors, use a 25 pins type with female connector conforming to MIL-C-24308.

- Connector manufacturers' example
- Fujitsu, Ltd.
 - Japan Aviation Electronics Industry, Ltd.
 - J.S.T. Mfg. Co., Ltd.
 - Hirose Electric Co., Ltd.

Electric Characteristics

Item	Characteristics
Conductor resistance Ω/km, 20°C	65 or less
Voltage limit VAC, 1 min.	1000
Insulation resistance MΩkm, 20°C	5 or less

Note) The min. bending radius of D-sub cable is 20 mm.

D-sub Connector Cable Assembly Terminal No.

Terminal no.	Lead wire color	Dot marking
1	Black	None
2	Brown	None
3	Red	None
4	Orange	None
5	Yellow	None
6	Pink	None
7	Blue	None
8	Purple	White
9	Gray	Black
10	White	Black
11	White	Red
12	Yellow	Red
13	Orange	Red
14	Yellow	Black
15	Pink	Black
16	Blue	White
17	Purple	None
18	Gray	None
19	Orange	Black
20	Red	White
21	Brown	White
22	Pink	Red
23	Gray	Red
24	Black	White
25	White	None

How to Order Manifold

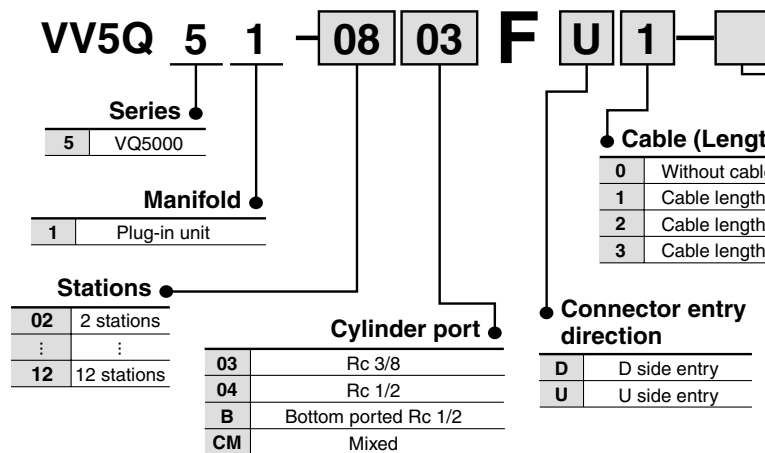

Option

Symbol	Option
Nil	None
CD1	Exhaust cleaner for Rc 1: D side exhaust
CD2	Exhaust cleaner for Rc 1 1/2: D side exhaust
CU1	Exhaust cleaner for Rc 1: U side exhaust
CU2	Exhaust cleaner for Rc 1 1/2: U side exhaust
K ⁽³⁾	Special wiring specifications (Except double wiring)
SB	Direct exhaust with silencer box: For mounting on both D and U sides
SD	Direct exhaust with silencer box: D side exhaust
SU	Direct exhaust with silencer box: U side exhaust

Note 1) When two or more symbols are specified, indicate them alphabetically. Example) -CD1K.
Note 2) Combination of [CU□] and [SD□] is not possible.
Note 3) Specify the wiring specifications on the manifold specification sheet.

Plug-in Unit Series VQ5000

● Electrical wiring specifications

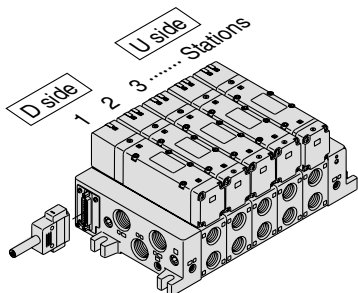

Stations are counted starting from the first station on the D side.

D-sub connector

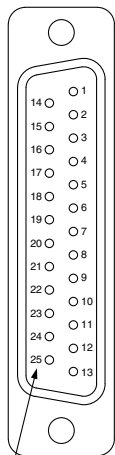

Connector terminal no.

Double wiring (connected to SOL. A and SOL. B) is adopted for the internal wiring of each station, regardless of valve and option types.

Mixed single and double wiring is available as an option. For details, refer to below.



Note) There is no polarity. It can also be used as a negative common.

Standard wiring

Terminal no.	Polarity	Lead wire color	Dot marking
1 station SOL.A 1	(-)	(+) Black	None
SOL.B 14	(-)	(+) Yellow	Black
2 stations SOL.A 2	(-)	(+) Brown	None
SOL.B 15	(-)	(+) Pink	Black
3 stations SOL.A 3	(-)	(+) Red	None
SOL.B 16	(-)	(+) Blue	White
4 stations SOL.A 4	(-)	(+) Orange	None
SOL.B 17	(-)	(+) Purple	None
5 stations SOL.A 5	(-)	(+) Yellow	None
SOL.B 18	(-)	(+) Gray	None
6 stations SOL.A 6	(-)	(+) Pink	None
SOL.B 19	(-)	(+) Orange	Black
7 stations SOL.A 7	(-)	(+) Blue	None
SOL.B 20	(-)	(+) Red	White
8 stations SOL.A 8	(-)	(+) Purple	White
SOL.B 21	(-)	(+) Brown	White
9 stations SOL.A 9	(-)	(+) Gray	Black
SOL.B 22	(-)	(+) Pink	Red
10 stations SOL.A 10	(-)	(+) White	Black
SOL.B 23	(-)	(+) Gray	Red
11 stations SOL.A 11	(-)	(+) White	Red
SOL.B 24	(-)	(+) Black	White
12 stations SOL.A 12	(-)	(+) Yellow	Red
SOL.B 25	(-)	(+) White	None
COM. 13	(+)	(-) Orange	Red

Positive common specifications Negative common (Note) specifications

- VQC
- SQ
- VQ0
- VQ4
- VQ5
- VQZ
- VQD

Special Wiring Specifications

Double wiring (connected to SOL. A and SOL. B) is used for the internal wiring of each station regardless of valve and option types. Mixed single and double wiring is available as an option.

1. How to Order

Indicate option symbol "K" in the manifold part number and be sure to specify station positions for single or double wiring on the manifold specification sheet.

2. Wiring specifications

Connections begin with the A side solenoid of the first station being connected to terminal no. 1, and continue in the order indicated by the arrows in the drawing without skipping any terminals. However, the maximum number of stations is 12.

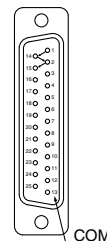

D-sub connector

How to Order Valves

VQ 5 1 0 0 5

Series: 5 VQ5000

Type of actuation: 1 (2 position single), 2 (2 position double), 3 (3 position closed center), 4 (3 position exhaust center), 5 (3 position pressure center), 6 (3 position double check)

Manual override: Nil (Non-locking push type), B (Locking type)

Light/Surge voltage suppressor: Nil (Yes), E (Without light, with surge voltage suppressor)

Coil voltage: 1 (100 VAC), 2 (200 VAC), 3 (110 VAC), 4 (220 VAC), 5 (24 VDC), 6 (12 VDC)

Function: Nil (Standard type), Y (Low wattage type), R (External pilot)

Seal: 0 (Metal seal), 1 (Rubber seal)

Note 1) Applicable to DC specifications.
 Note 2) Refer to page 2-6-39 for details on external pilot specifications.
 Note 3) When two or more symbols are specified, indicate them alphabetically.

How to Order Manifold Assembly

Specify the part numbers for valves and options together beneath the manifold base part number.

<Example>

D-sub connector kit with cable (3 m)
 VV5Q51-0503FD2 -1 set - Manifold base part no.
 *VQ5100-5 2 sets - Valve part no. (Stations 1 and 2)
 *VQ5200-5 2 sets - Valve part no. (Stations 3 and 4)
 *VQ5300-5 1 set - Valve part no. (Station 5)

Prefix the asterisk to the part nos. of the solenoid valve, etc.

Enter in order starting from the first station on the D side. When entry of part numbers becomes complicated, indicate in the manifold specification sheet.

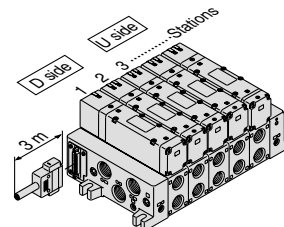

F Kit (D-sub Connector kit)

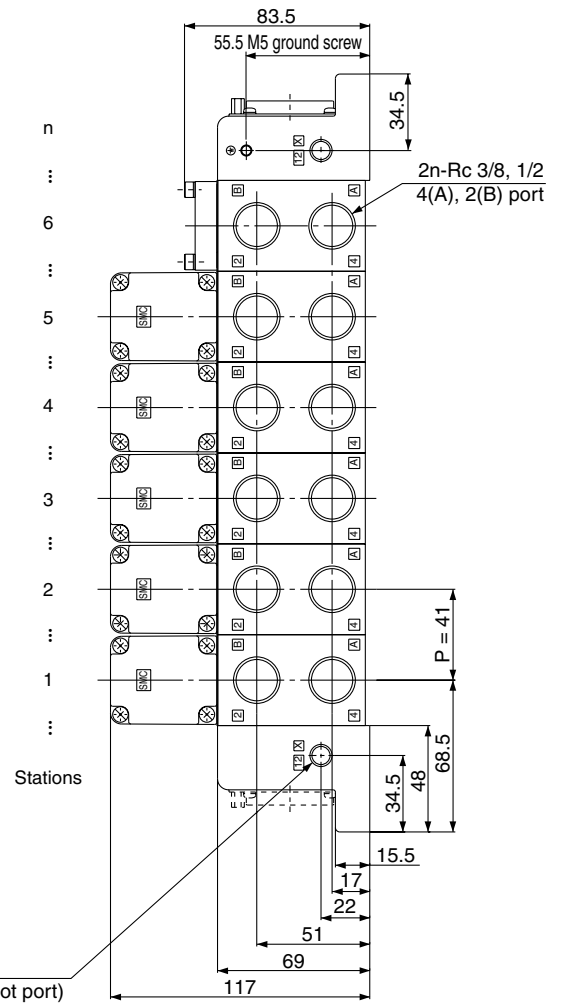
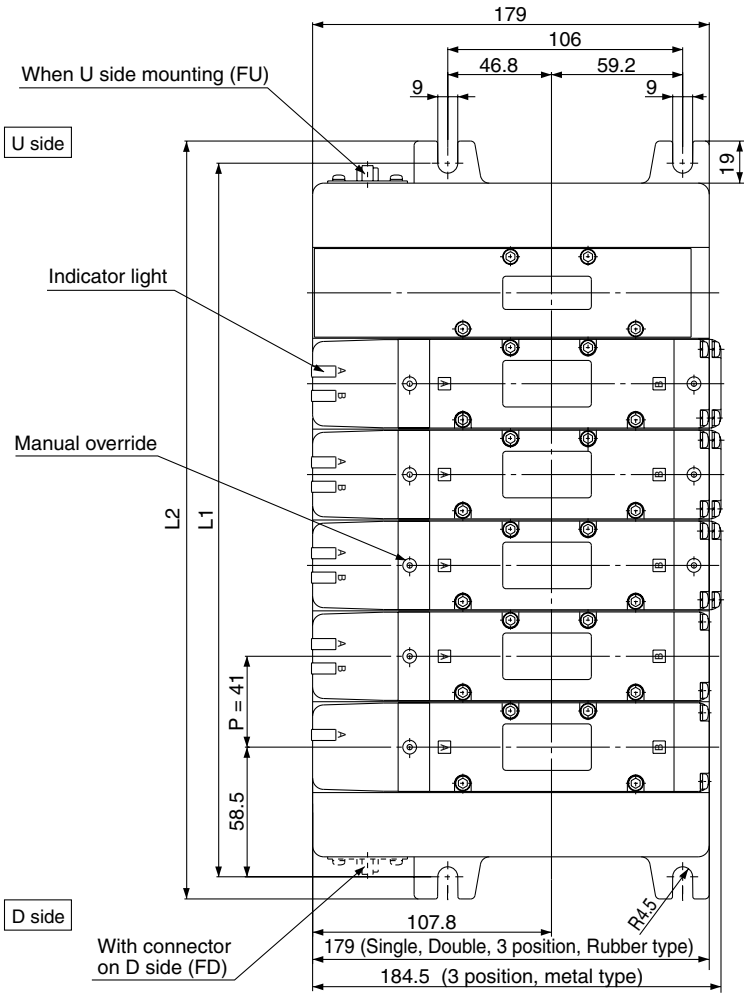
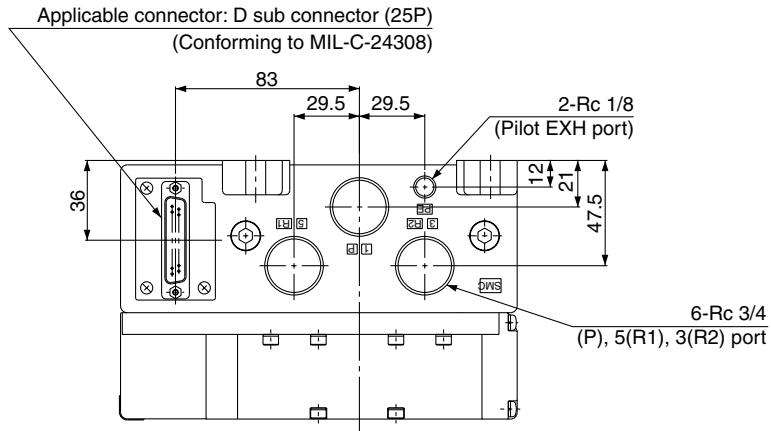

Plug-in Unit Series VQ5000

Bottom ported drawing

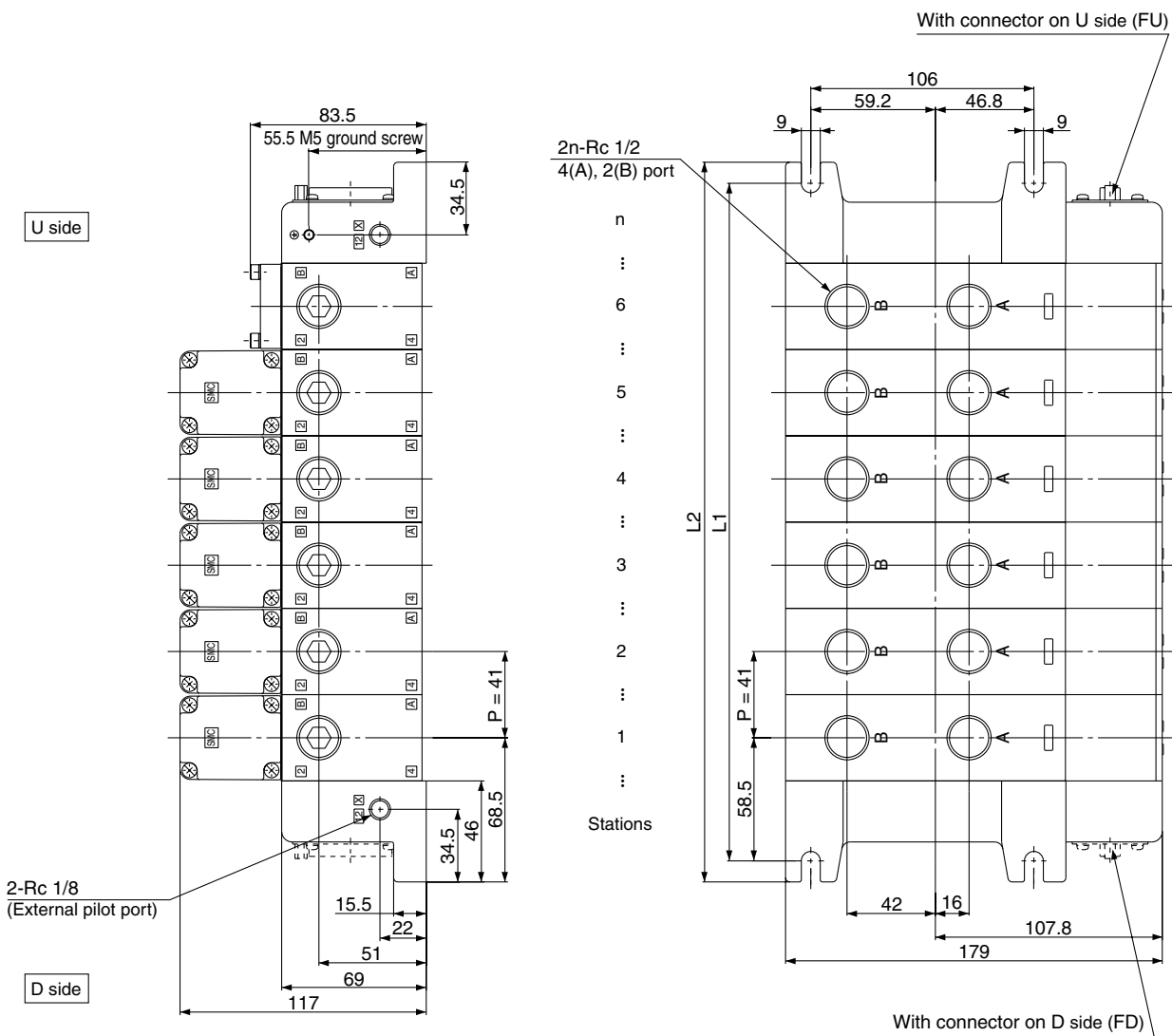

- VQC
- SQ
- VQ0
- VQ4
- VQ5**
- VQZ
- VQD

Dimensions

Formula: L1 = 41n + 76, L2 = 41n + 96
n: Stations (Maximum 12 stations)

L	n	1	2	3	4	5	6	7	8	9	10	11	12
L1		117	158	199	240	281	322	363	404	445	486	527	568
L2		137	178	219	260	301	342	383	424	465	506	547	588

Series VQ5000

T Kit (Terminal block box kit)

IP65 compliant

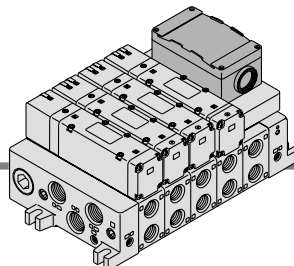

- Enclosure IP65 compliant
- This type has a small terminal block inside a junction box. The provision of a G 3/4 electrical entry allows connection of conduit fittings.
- Maximum stations are 11. (12 stations as an option)
- 1 station is used for terminal block box mounting.

Manifold Specifications

Series	4(A), 2(B) port location	Porting specifications		Applicable stations
		1(P), 5(R1), 3(R2)	4(A), 2(B)	
VQ5000	Side	Rc 3/4	Rc 3/8 Rc 1/2	Max. 12 stations
	Bottom		Rc 1/2	

Terminal Block Connections

Step 1. How to remove terminal block cover
Loosen the 4 mounting screws (M4) and open the terminal block cover.

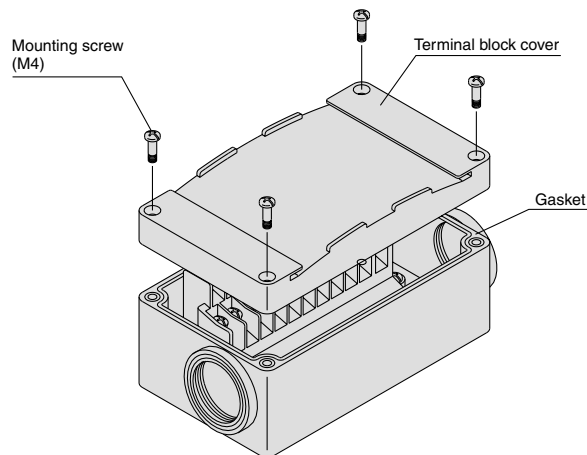

Step 2. The diagram on the right shows the terminal block wiring.
All stations are provided with double wiring regardless of the valves which are mounted. Connect each wire to the power supply side, according to the markings provided inside the terminal block.

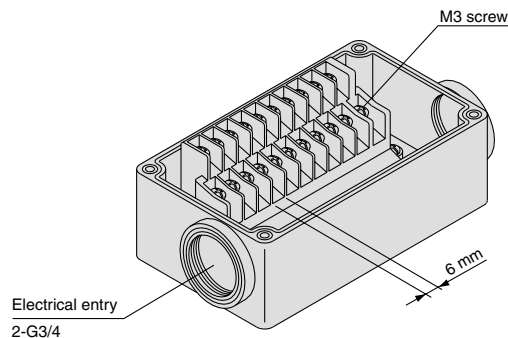

Step 3. How to attach the terminal block cover
Securely tighten the screws with the torque shown in the table below, after confirming that the gasket is installed correctly.

Proper tightening torque (N·m)
0.7 to 1.2

- Applicable terminal 1.25-3s, 1.25Y-3, 1.25Y-3N, 1.25Y-3.5

How to Order Manifold

VV5Q 5 1 -08 03 T -K

Series
5 VQ5000

Manifold
1 Plug-in unit

Stations

02	2 stations
⋮	⋮
12	12 stations

Note 1) Add 1 station for terminal block box.
Note 2) The maximum number of stations can be expanded with optional special wiring specifications. Refer to page 2-6-15 for details.



Box mounting position

D	D side mounting
U	U side mounting

Cylinder port

03	Rc 3/8
04	Rc 1/2
B	Bottom ported Rc 1/2
CM	Mixed

Option

Symbol	Option
Nil	None
CD1 ⁽²⁾	Exhaust cleaner for Rc 1: D side exhaust
CD2 ⁽²⁾	Exhaust cleaner for Rc 1 1/2: D side exhaust
CU1 ⁽²⁾	Exhaust cleaner for Rc 1: U side exhaust
CU2 ⁽²⁾	Exhaust cleaner for Rc 1 1/2: U side exhaust
K ⁽⁴⁾	Special wiring specification (Except double wiring)
N	Name plate
SD ⁽²⁾	Direct exhaust with silencer box: D side exhaust
SU ⁽²⁾	Direct exhaust with silencer box: U side exhaust
W	IP65 enclosure

Note 1) When two or more symbols are specified, indicate them alphabetically. Example) -CD1K.
Note 2) Combination of [C□□] and [SU] is not possible.
Note 3) Specify the wiring specifications on the manifold specification sheet.



Plug-in Unit Series VQ5000

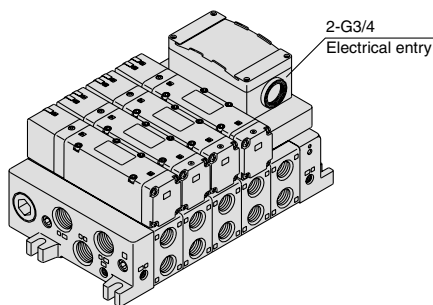

Stations are counted starting from the first station on the D side.

Electrical wiring specifications (IP65 available)

Standard wiring

	Terminal no.	Polarity
1 station	SOL.A 1A	(-) (+)
	SOL.B 1B	(-) (+)
2 stations	SOL.A 2A	(-) (+)
	SOL.B 2B	(-) (+)
3 stations	SOL.A 3A	(-) (+)
	SOL.B 3B	(-) (+)
4 stations	SOL.A 4A	(-) (+)
	SOL.B 4B	(-) (+)
5 stations	SOL.A 5A	(-) (+)
	SOL.B 5B	(-) (+)
6 stations	SOL.A 6A	(-) (+)
	SOL.B 6B	(-) (+)
7 stations	SOL.A 7A	(-) (+)
	SOL.B 7B	(-) (+)
8 stations	SOL.A 8A	(-) (+)
	SOL.B 8B	(-) (+)
9 stations	SOL.A 9A	(-) (+)
	SOL.B 9B	(-) (+)
10 stations	SOL.A 10A	(-) (+)
	SOL.B 10B	(-) (+)
	COM	(+) (-)

Positive Negative
common common

Double wiring (connected to SOL. A and SOL. B) is adopted for the internal wiring of each station, regardless of valve and option types. Mixed single and double wiring is available as an option.

Note) There is no polarity. It can also be used as a negative common.

Special Wiring Specifications

Double wiring (connected to SOL. A and SOL. B) is used for the internal wiring of each station regardless of valve and option types. The optional specification permits mixture of single and double wiring. However, the maximum number of stations is 12.

1. How to Order

Indicate option symbol ("K") in the manifold part number and be sure to specify station positions for single or double wiring on the manifold specification sheet.

2. Wiring specifications

Connections begin with the A side solenoid of the first station being connected to terminal no. 1, and continue in the order indicated by the arrows in the drawing without skipping any terminals.

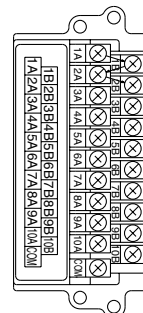

How to Order Valves

VQ 5 1 0 0 5

Series

5	VQ5000
---	--------

Type of actuation

1	2 position single
2	2 position double
3	3 position closed center
4	3 position exhaust center
5	3 position pressure center
6	3 position double check

Seal

0	Metal seal
1	Rubber seal

Function

Nil	Standard type (1 W)
Y ⁽¹⁾	Low wattage type (0.5 W)
R ⁽²⁾	External pilot

Enclosure

Nil	Dusttight
W	Dusttight/Low jetproof type (IP65)

Manual override

Nil	Non-locking push type (Tool required)
B	Locking type (Tool required)

Light/Surge voltage suppressor

Nil	Yes
E	Without light, with surge voltage suppressor

Coil voltage

1	100 VAC (50/60 Hz)
2	200 VAC (50/60 Hz)
3	110 VAC (50/60 Hz)
4	220 VAC (50/60 Hz)
5	24 VDC
6	12 VDC

Note 1) Applicable to DC specifications.
Note 2) Refer to page 2-6-39 for details on external pilot specifications.
Note 3) When two or more symbols are specified, indicate them alphabetically.

How to Order Manifold Assembly

Specify the part numbers for valves and options together beneath the manifold base part number.

<Example>

Terminal block box kit

- VV5Q51-0603TU 1 set —Manifold base part no.
- * VQ5100-5 2 sets—Valve part no. (Stations 1 and 2)
- * VQ5200-5 2 sets—Valve part no. (Stations 3 and 4)
- * VQ5300-5 1 set —Valve part no. (Station 5)

Prefix the asterisk to the part nos. of the solenoid valve, etc.

Enter in order starting from the first station on the D side. When entry of part numbers becomes complicated, indicate in the manifold specification sheet.

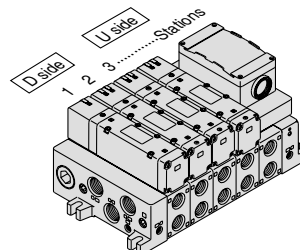

T Kit (Terminal block box kit)

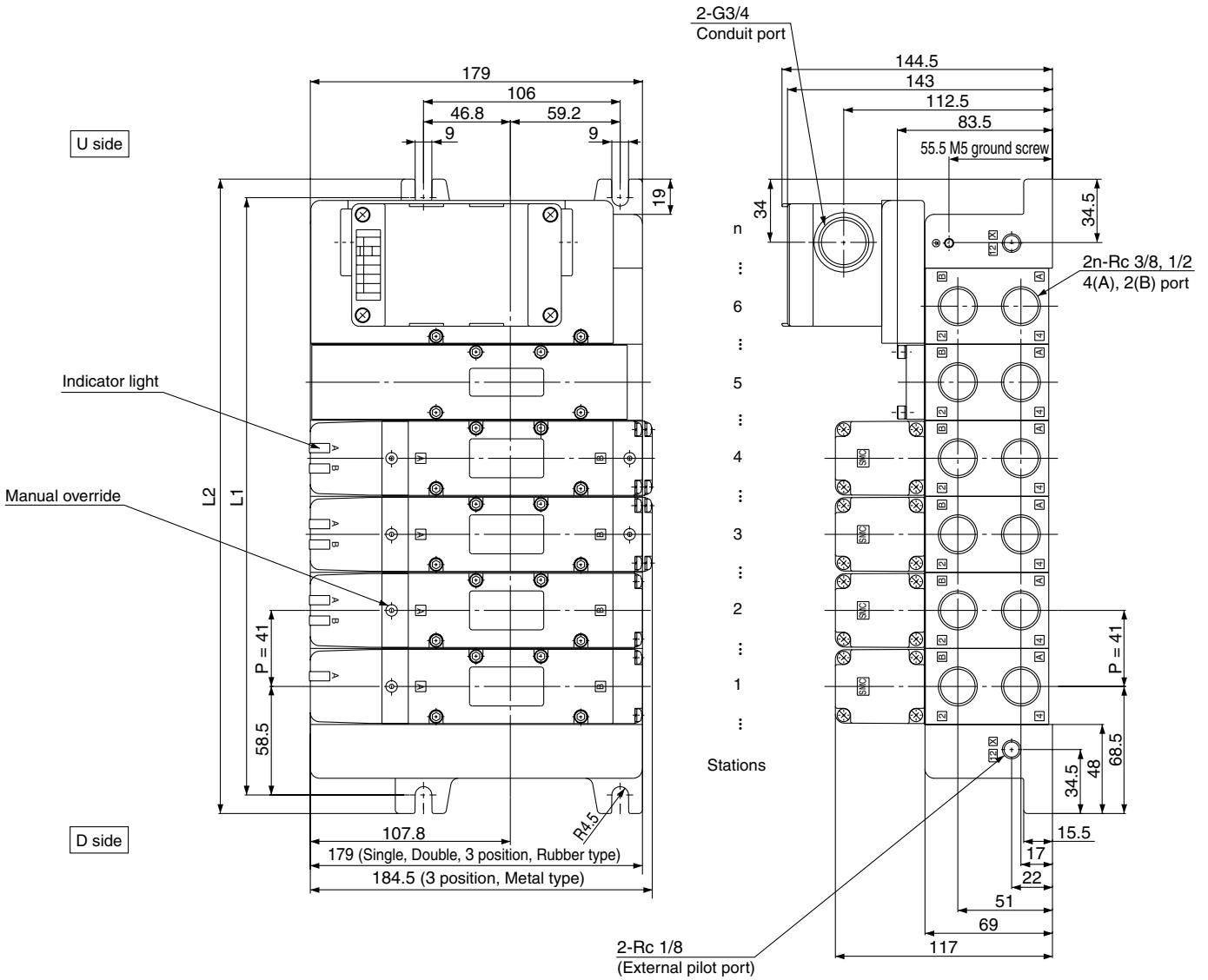
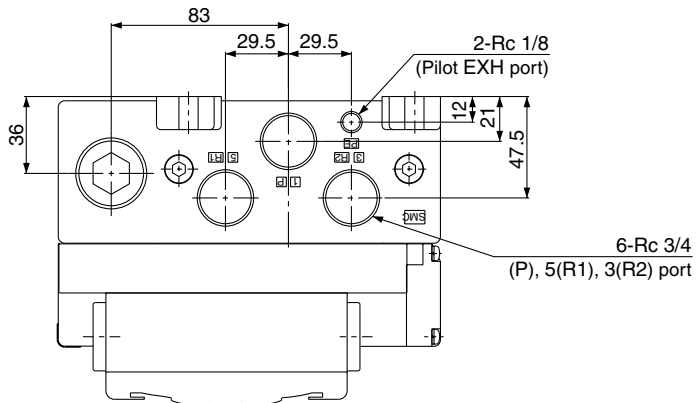

Plug-in Unit Series VQ5000

Bottom ported drawing

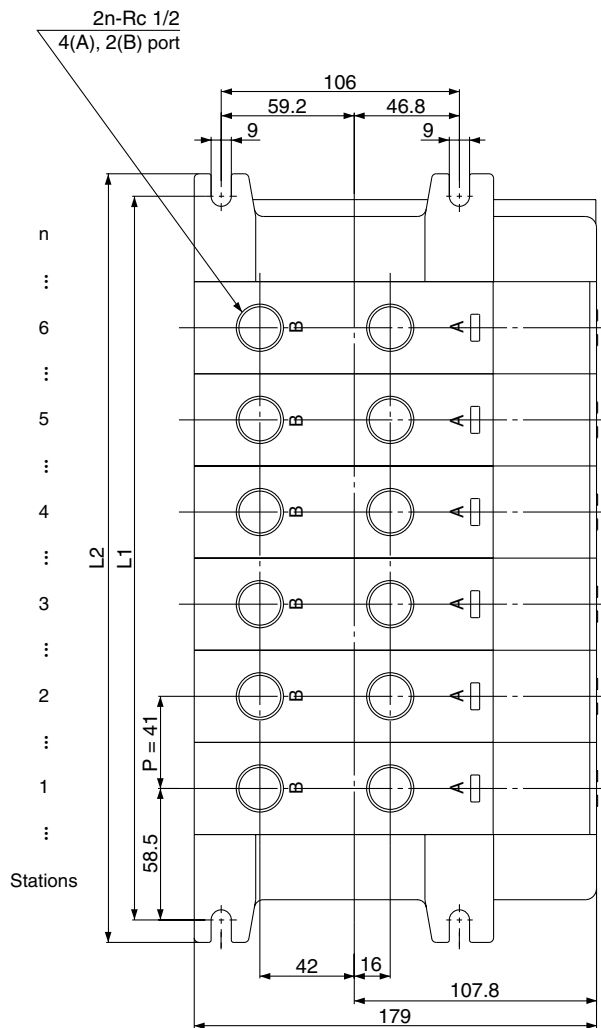
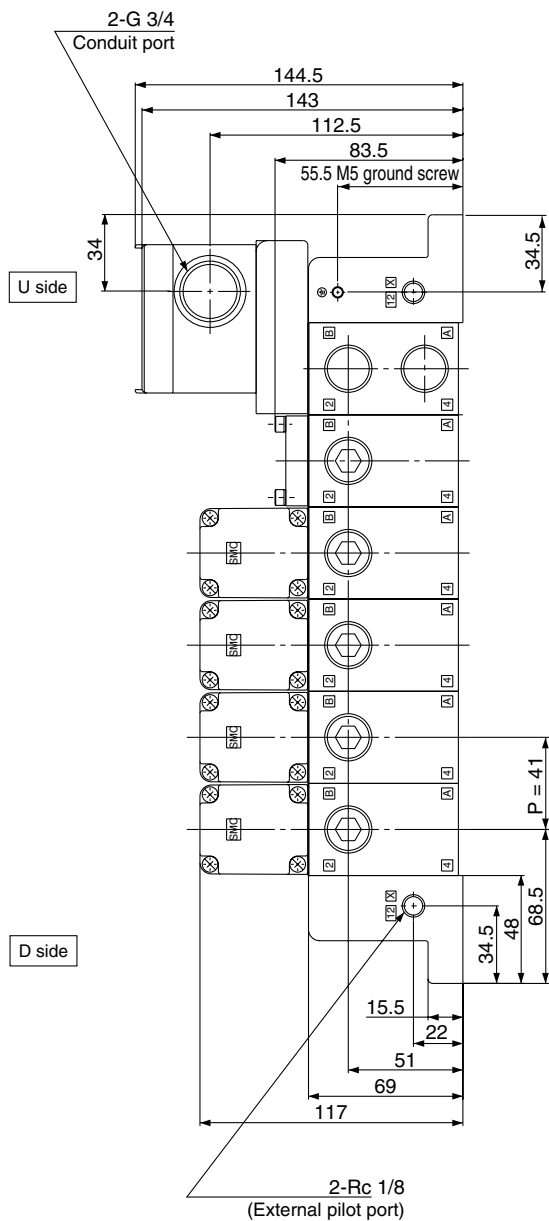

VQC

SQ

VQ0

VQ4

VQ5

VQZ

VQD

Formula: $L1 = 41n + 76$, $L2 = 41n + 96$

n: Stations (Maximum 12 stations)

* Including 1 station for terminal box mounting.

Dimensions

L	n	2	3	4	5	6	7	8	9	10	11	12
L1		158	199	240	281	322	363	404	445	486	527	568
L2		178	219	260	301	342	383	424	465	506	547	588

Series VQ5000

T1 Kit (Individual terminal block kit)

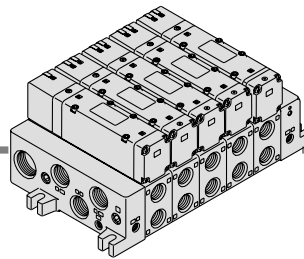

- When the junction cover on the manifold is opened, terminal box is installed in the manifold block. Lead wire from a solenoid is connected with the terminals on the terminal box in the bottom side. (The terminal box is connected with lead wire for both SOL. A and SOL. B and they correspond with the marking 1, 2, 3, 4 on the terminal box. Refer to how to connect with the terminal box.)
- Maximum stations are 12.

Manifold Specifications

Series	Porting specifications			Applicable stations
	4(A), 2(B) port location	Port size		
		1(P), 5(R1), 3(R2)	4(A), 2(B)	
VQ5000	Side	Rc 3/4	Rc 3/8, 1/2	Max. 12 stations
	Bottom		Rc 1/2	

Terminal Block Connections

Terminal block marking	1	3	2	4
Model VQ510 ₁ ⁰	A side +	A side -		
VQ520 ₁ ⁰	A side +	A side -	B side +	B side -
VQ540 ₅ ³	A side +	A side -	B side +	B side -

- Compatible crimp terminals: 1.25-3S, 1.25Y-3, 1.25Y-3N, 1.25Y-3.5
- There is no polarity (+, -).

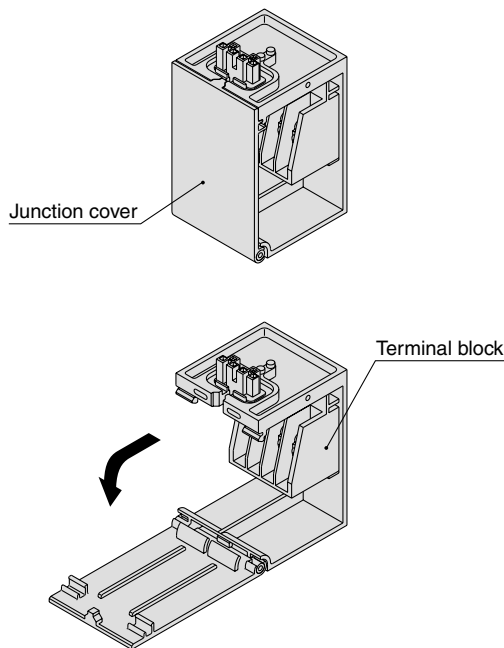
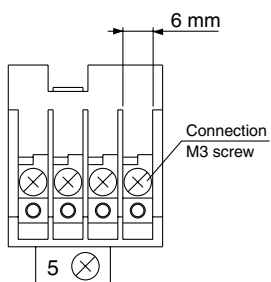
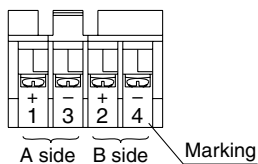

How to Order Manifold

VV5Q 5 1 -08 03 T1 -SD

Series
5 VQ5000

Manifold
1 Plug-in unit

Stations

1	1 station
⋮	⋮
12	12 stations

Cylinder port

03	Rc 3/8
04	Rc 1/2
B	Bottom ported Rc 1/2
CM	Mixed

Option

Symbol	Option
Nil	None
CD1 ^{Note)}	Exhaust cleaner for Rc 1: D side exhaust
CD2 ^{Note)}	Exhaust cleaner for Rc 1 1/2: D side exhaust
CU1 ^{Note)}	Exhaust cleaner for Rc 1: U side exhaust
CU2 ^{Note)}	Exhaust cleaner for Rc 1 1/2: U side exhaust
SB ^{Note)}	Direct exhaust with silencer box: Exhaust from both U and D side
SD ^{Note)}	Direct exhaust with silencer box: D side exhaust
SU	Direct exhaust with silencer box: U side exhaust

Note) Combination of [C_U^D] and [S_D^D] is not possible.

Plug-in Unit Series VQ5000

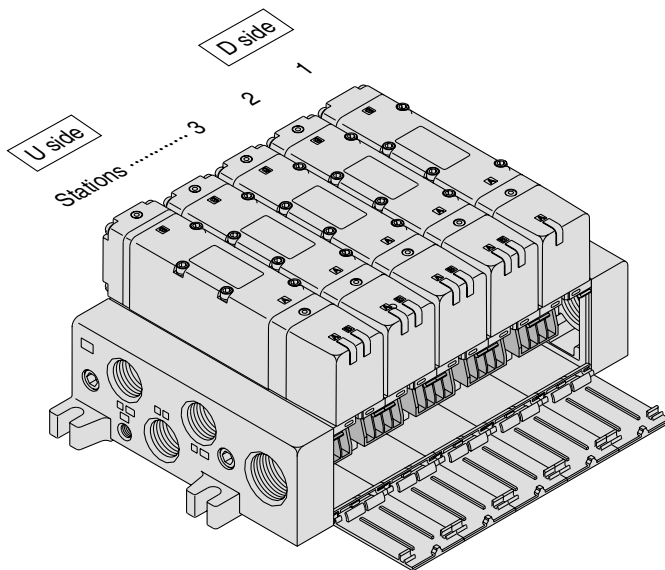

- VQC
- SQ
- VQ0
- VQ4
- VQ5**
- VQZ
- VQD

How to Order Valves

VQ 5 1 0 0 — **5** — — —

Series

5	VQ5000
---	--------

Type of actuation

1	2 position single
2	2 position double
3	3 position closed center
4	3 position exhaust center
5	3 position pressure center
6	3 position double check

Seal

0	Metal seal
1	Rubber seal

Function

Nil	Standard type (1 W)
Y ⁽¹⁾	Low wattage type (0.5 W)
R ⁽²⁾	External pilot

Manual override

Nil	Non-locking push type (Tool required)
B	Locking type (Tool required)

Light/Surge voltage suppressor

Nil	Yes
E	Without light, with surge voltage suppressor

Coil voltage

1	100 VAC (50/60 Hz)
2	200 VAC (50/60 Hz)
3	110 VAC (50/60 Hz)
4	220 VAC (50/60 Hz)
5	24 VDC
6	12 VDC

Note 1) Applicable to DC specification.
 Note 2) Refer to page 2-6-39 for details on external pilot specifications.
 Note 3) When two or more symbols are specified, indicate them alphabetically.

How to Order Manifold Assembly

Specify the part numbers for valves and options together beneath the manifold base part number.

<Example>

Individual terminal block kit

VV5Q51-0503T1... 1 set —Manifold base part no.
 *VQ5100-5 2 sets—Valve part no. (Stations 1 and 2)
 *VQ5200-5 2 sets—Valve no. (Stations 3 and 4)
 *VQ5300-5 1 set —Valve part no. (Station 5)

Prefix the asterisk to the part nos. of the solenoid valve, etc.

Enter in order starting from the first station on the D side. When entry of part numbers becomes complicated, indicate in the manifold specification sheet.

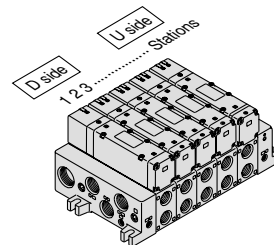

T1 Kit (Individual terminal block kit)

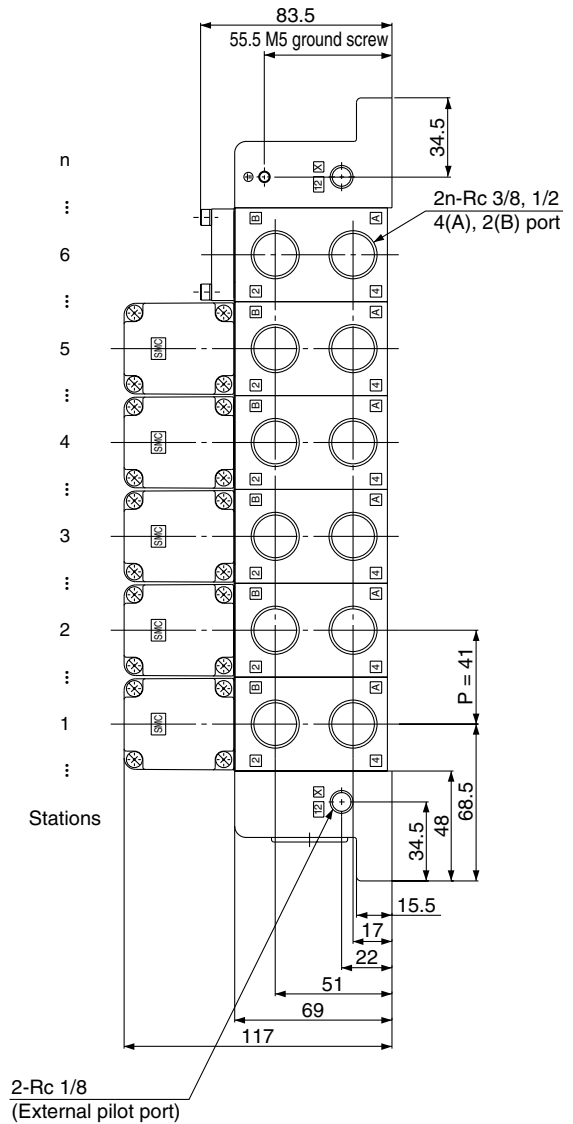
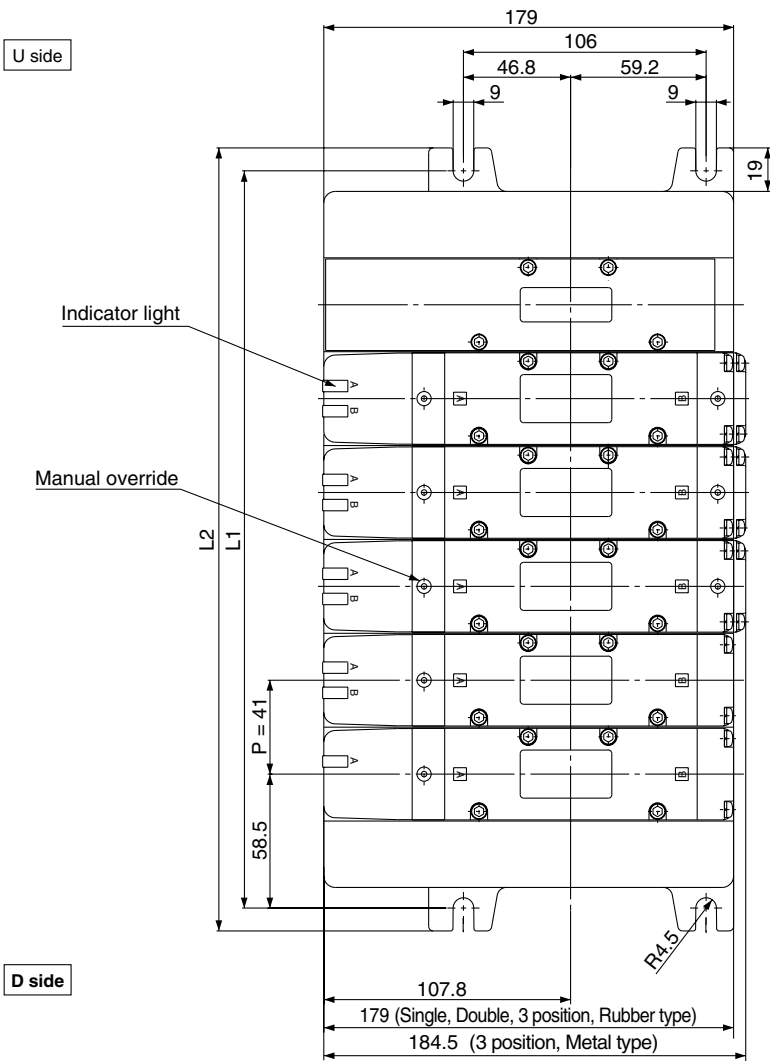
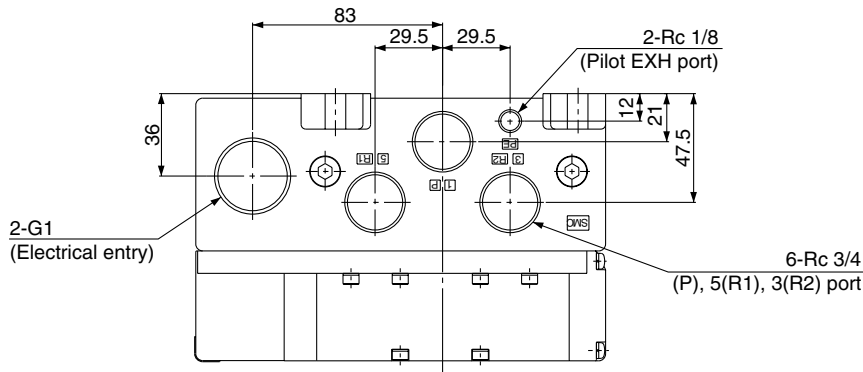

Plug-in Unit Series VQ5000

Bottom ported drawing

- VQC
- SQ
- VQ0
- VQ4
- VQ5**
- VQZ
- VQD

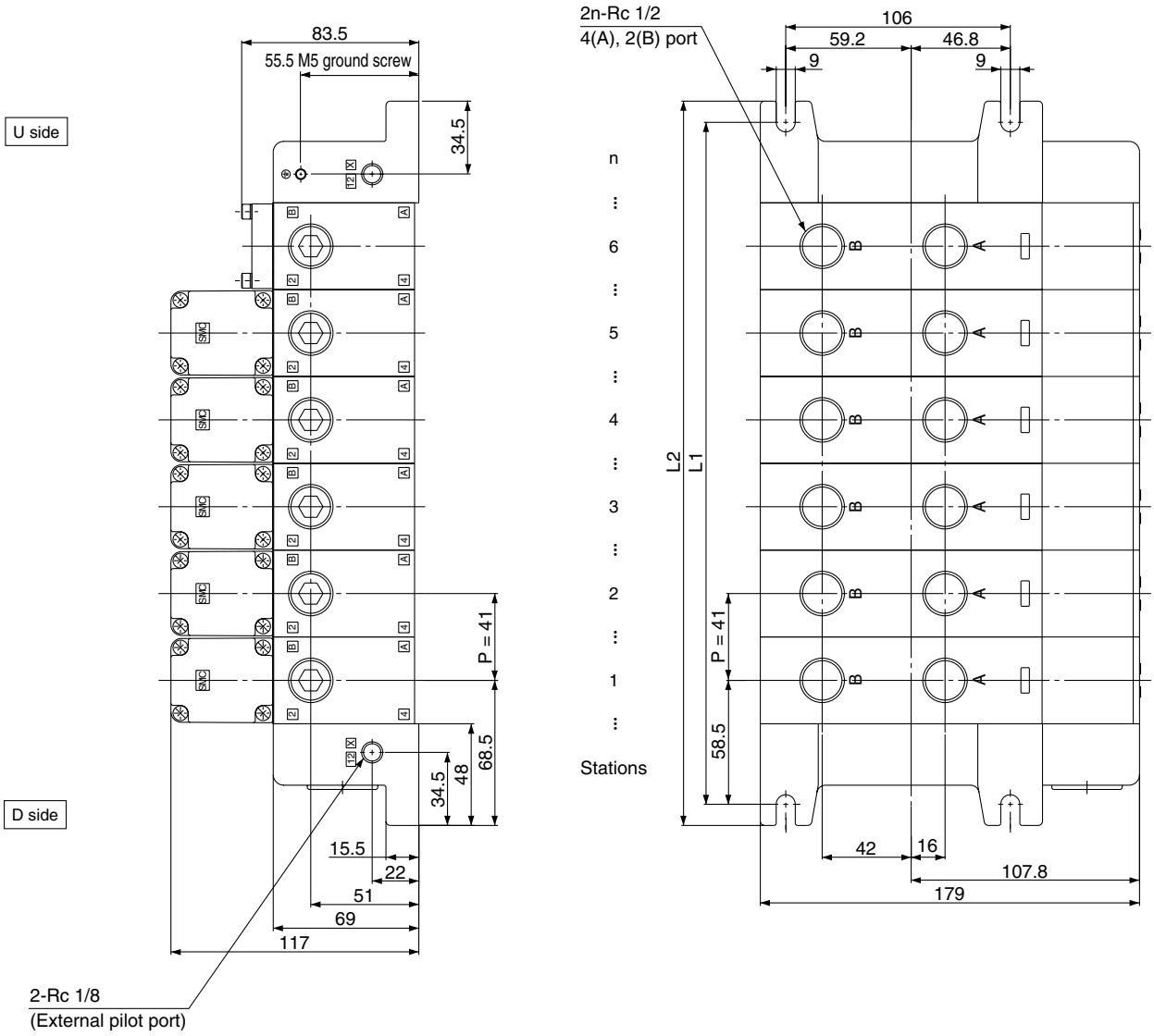

Dimensions

Formula: $L1 = 41n + 76$, $L2 = 41n + 96$
 n: Stations (Maximum 12 stations)

L \ n	1	2	3	4	5	6	7	8	9	10	11	12
L1	117	158	199	240	281	322	363	404	445	486	527	568
L2	137	178	219	260	301	342	383	424	465	506	547	588

Series VQ5000

L Kit (Lead wire cable)

IP65 compliant

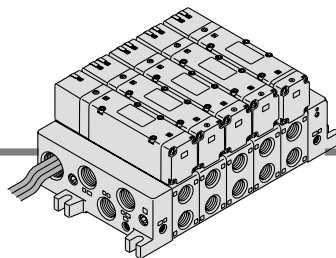

- Enclosure IP65 compliant
- Direct electrical entry type available with two or more stations.
- Electrical entry can be selected on either the U side or the D side according to the mounting orientation.
- Maximum stations are 12.

Manifold Specifications

Series	Porting specifications			Applicable stations
	4(A), 2(B) port location	Port size		
VQ5000	Side	Rc 3/4	4(A), 2(B) Rc 3/8 Rc 1/2	Max. 12 stations
	Bottom		Rc 1/2	

Wiring Specifications

Three lead wires are attached to each station regardless of the type of valve which is mounted. The red wire is for COM connection.

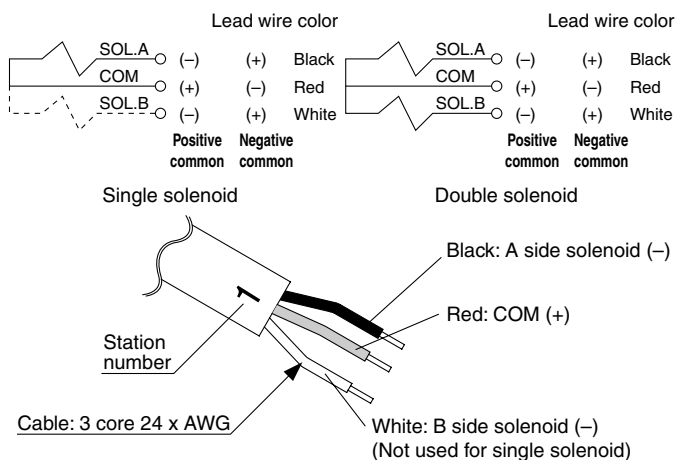

Lead Wire Assembly with Connector

Lead wire length	Part no.
0.6 m	VVQ5000-44A-8-□
1.5 m	VVQ5000-44A-15-□
3 m	VVQ5000-44A-30-□

□: Number of stations 1 to 12

For different lead wire lengths, order a lead wire assembly with connector shown in the table on the right. Note) There is no polarity. It can also be used as a negative common.

How to Order Manifold

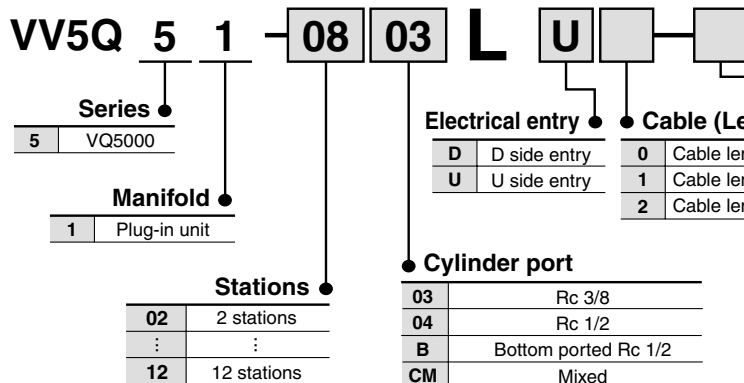

Symbol	Option
Nil	None
CD1 ^{Note)}	Exhaust cleaner for Rc 1: D side exhaust
CD2 ^{Note)}	Exhaust cleaner for Rc 1 1/2: D side exhaust
CU1 ^{Note)}	Exhaust cleaner for Rc 1: U side exhaust
CU2 ^{Note)}	Exhaust cleaner for Rc 1 1/2: U side exhaust
SB	Direct exhaust with silencer box: Exhaust from both U and D sides
SD ^{Note)}	Direct exhaust with silencer box: D side exhaust
SU ^{Note)}	Direct exhaust with silencer box: U side exhaust
W	IP65 enclosure

Note) Combination of [C□□] and [S□] is not possible.

Plug-in Unit Series VQ5000

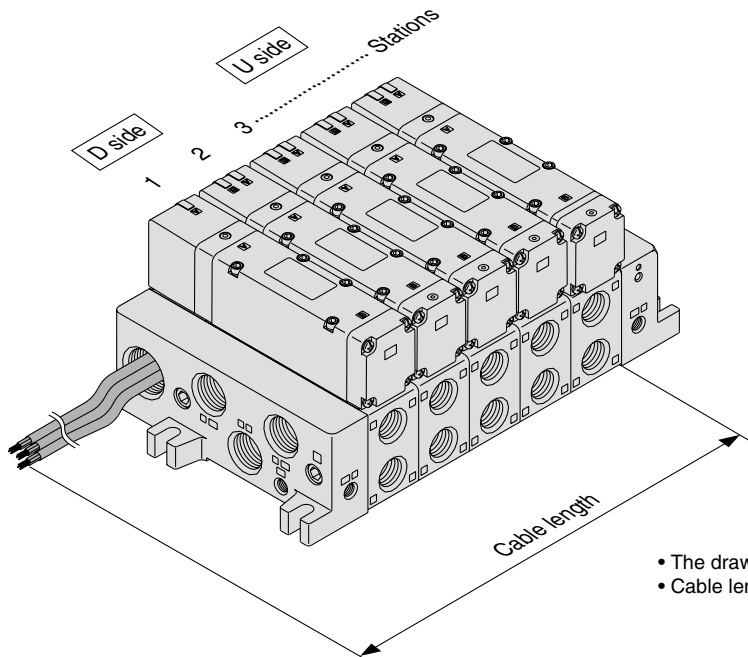

- The drawing shows the electrical entry on the D side.
- Cable length is measured from the solenoid valve body.

- VQC
- SQ
- VQ0
- VQ4
- VQ5**
- VQZ
- VQD

How to Order Valves

VQ 5 1 0 0 — **5** — — — —

Series

5	VQ5000
---	--------

Type of actuation

1	2 position single
2	2 position double
3	3 position closed center
4	3 position exhaust center
5	3 position pressure center
6	3 position double check

Seal

0	Metal seal
1	Rubber seal

Enclosure

Nil	Dusttight
W	Dusttight/Low jetproof type(IP65)

Manual override

Nil	Non-locking push type (Tool required)
B	Locking type (Tool required)

Light/Surge voltage suppressor

Nil	Yes
E	Without light, with surge voltage suppressor

Coil voltage

1	100 VAC (50/60 Hz)
2	200 VAC (50/60 Hz)
3	110 VAC (50/60 Hz)
4	220 VAC (50/60 Hz)
5	24 VDC
6	12 VDC

Function

Nil	Standard type (1 W)
Y ⁽¹⁾	Low wattage type (0.5 W)
R ⁽²⁾	External pilot

Note 1) Applicable to DC specification.
 Note 2) Refer to page 2-6-39 for details on external pilot specifications.
 Note 3) When two or more symbols are specified, indicate them alphabetically.

How to Order Manifold Assembly

Specify the part numbers for valves and options together beneath the manifold base part number.

<Example>

Lead wire kit with cable (3 m)

- VV5Q51-0503LD2 ...1 set—Manifold base part no.
- *VQ5100-52 sets—Valve part no. (Stations 1 and 2)
- *VQ5200-52 sets—Valve part no. (Stations 3 and 4)
- *VQ5300-51 set—Valve part no. (Station 5)

Prefix the asterisk to the part nos. of the solenoid valve, etc.

Enter in order starting from the first station on the D side. When entry of part numbers becomes complicated, indicate in the manifold specification sheet.

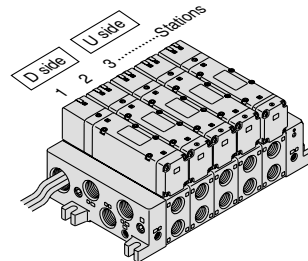

L Kit (Lead wire cable)

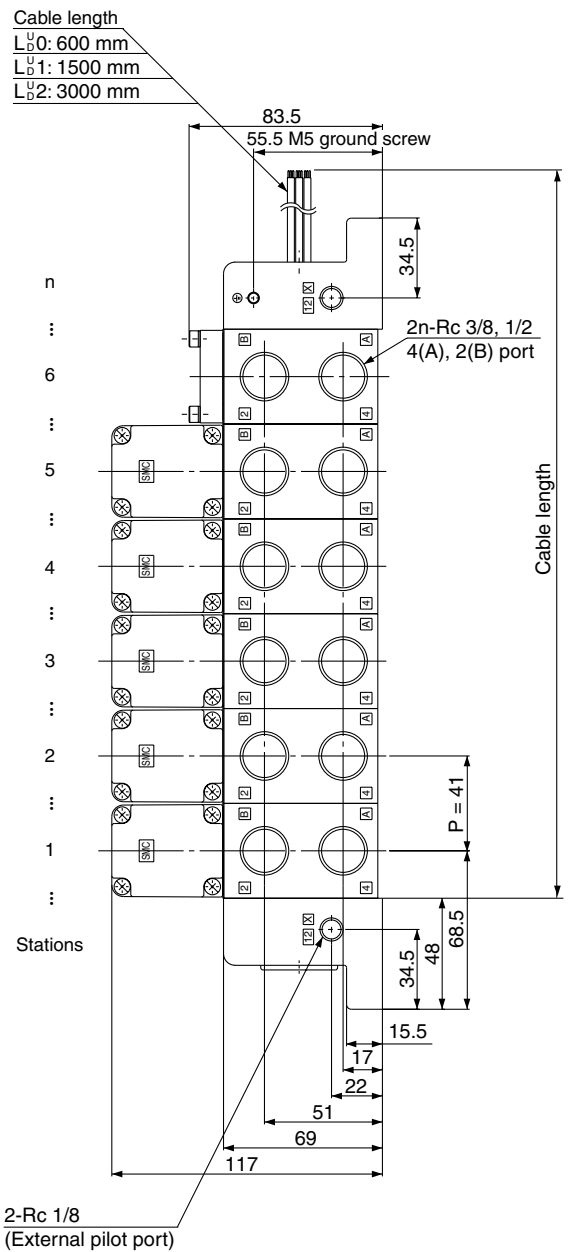
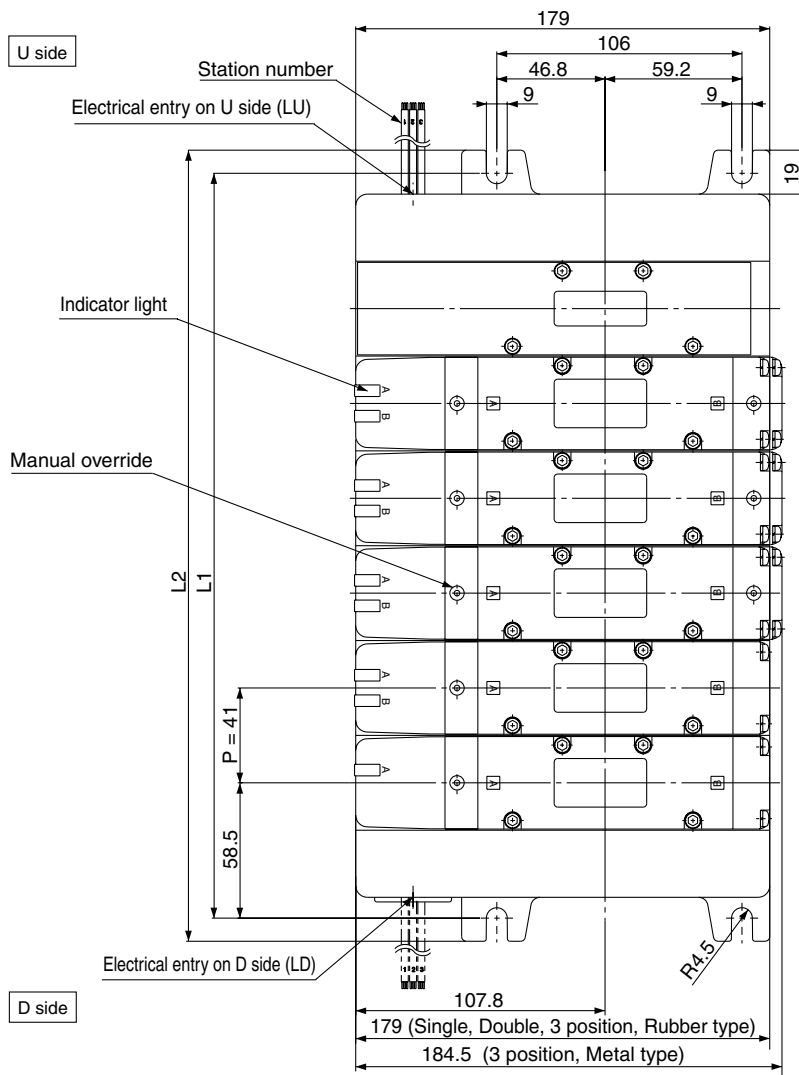
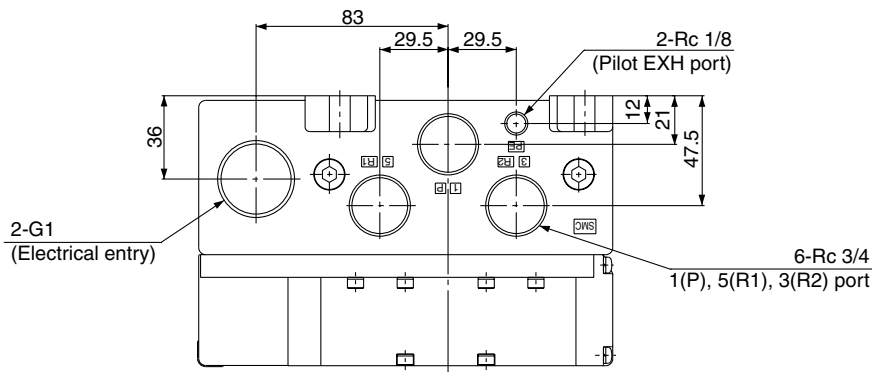

Plug-in Unit Series VQ5000

Bottom ported drawing

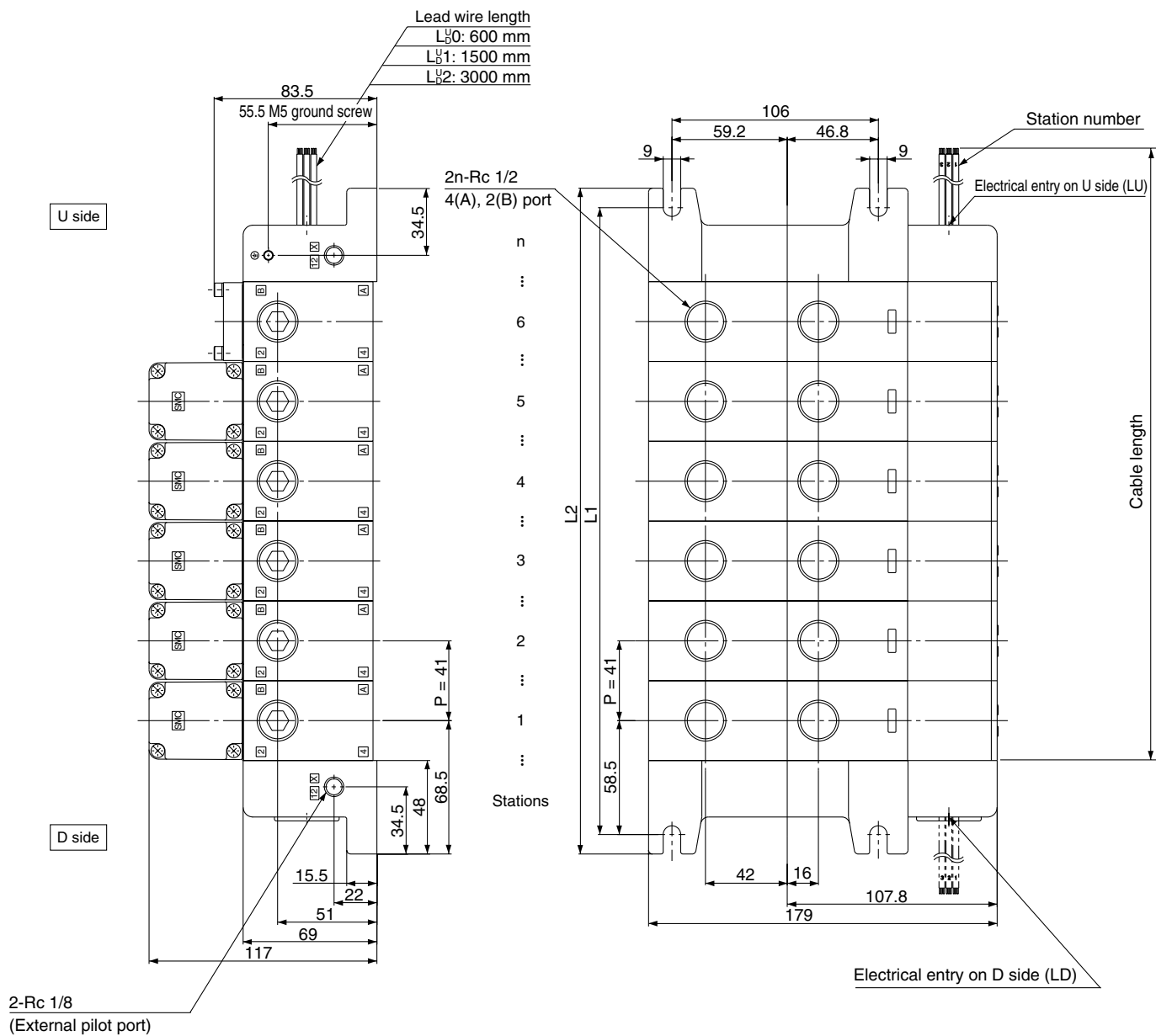

- VQC
- SQ
- VQ0
- VQ4
- VQ5**
- VQZ
- VQD

Formula: $L_1 = 41n + 76$, $L_2 = 41n + 96$
 n: Stations (Maximum 12 stations)

Dimensions

L \ n	1	2	3	4	5	6	7	8	9	10	11	12
L1	117	158	199	240	281	322	363	404	445	486	527	568
L2	137	178	219	260	301	342	383	424	465	506	547	588

Series VQ5000

S Kit (Serial transmission unit)

IP65 compliant

- The serial transmission system reduces wiring work, while minimizing wiring and saving space.
- The system is available in types such as the type SA for equipment with a maximum of 32 input/output points (a general purpose type for small scale systems), the type SB capable of controlling up to 512 points of input/output (Mitsubishi Electric compatible), the type SC (OMRON compatible), the type SD (SHARP compatible, 504 points max.), the type SF (NKE compatible, 128 points max.), the type SJ (SUNX compatible), the type SK (Fuji Electric compatible), the type SQ (OMRON Compo Bus/D compatible), and the type SR (OMRON Compo Bus/S compatible).
- Maximum 9 stations (12 stations available as an option. Indicate 10 to 12 stations on the manifold specification sheet.)
- One station is used for serial unit mounting.

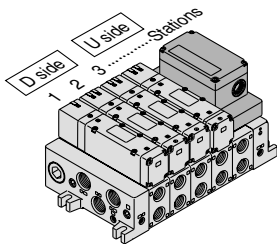

- Stations are counted from station 1 on the D side.
- Double wiring (connected to SOL. A and SOL. B) is adopted for the internal wiring of each station, regardless of valve and option types. Mixed single and double wiring is available as an option.

Item	Specifications
External power supply	24 VDC +10%, -5%
Current consumption (Internal unit)	SA, SB, SBB, SD, SF, SJ, SK, SQ, SR, SV: 0.1A SC: 0.3A

Manifold Specifications

Series	Porting specifications		Applicable stations
	4(A), 2(B) port location	Port size	
VQ5000		Side	Rc 3/4
	Bottom	Rc 1/2	

Name of terminal block (LED)	Type SA With general type SI unit (Series EX300)	Type SB Mitsubishi Electric Corporation MELSECNET/MINI-S3 Data Link System																		
		<table border="1"> <thead> <tr> <th>LED</th> <th>Description</th> </tr> </thead> <tbody> <tr> <td>TRD</td> <td>Lighting during data reception</td> </tr> <tr> <td>RUN/ERR</td> <td>Blinking when received data is normal; Lighting when data reception</td> </tr> </tbody> </table>	LED	Description	TRD	Lighting during data reception	RUN/ERR	Blinking when received data is normal; Lighting when data reception	<table border="1"> <thead> <tr> <th>LED</th> <th>Description</th> </tr> </thead> <tbody> <tr> <td>POWER</td> <td>Lighting when power is turned ON</td> </tr> <tr> <td>RUN</td> <td>Lighting when data transmission with the master station is normal</td> </tr> <tr> <td>RD</td> <td>Lighting during data reception</td> </tr> <tr> <td>SD</td> <td>Lighting during data transmission</td> </tr> <tr> <td>ERR.</td> <td>Lighting when reception data error occurs. Light turns off when the error is corrected.</td> </tr> </tbody> </table>	LED	Description	POWER	Lighting when power is turned ON	RUN	Lighting when data transmission with the master station is normal	RD	Lighting during data reception	SD	Lighting during data transmission	ERR.
LED	Description																			
TRD	Lighting during data reception																			
RUN/ERR	Blinking when received data is normal; Lighting when data reception																			
LED	Description																			
POWER	Lighting when power is turned ON																			
RUN	Lighting when data transmission with the master station is normal																			
RD	Lighting during data reception																			
SD	Lighting during data transmission																			
ERR.	Lighting when reception data error occurs. Light turns off when the error is corrected.																			

* For details on specifications and handling, refer to the separate technical instruction manual.

How to Order Manifold

VV5Q 5 1 - 08 03 S U Q

Series
5 VQ5000

Manifold
1 Plug-in unit

Stations
02 2 stations
: :
12 12 stations

Note) Add 1 station for serial unit mounting.

Cylinder port
03 Rc 3/8
04 Rc 1/2
B Bottom ported Rc 1/2
CM Mixed

Option

Model	Description
O	Without SI unit
A	With general type SI unit (Series EX300)
B	Mitsubishi Electric Corp.: MELSECNET/MINI-S3 Data Link System
BB	Mitsubishi Electric Corp.: MELSECNET/MINI-S3 Data Link System (2 power supply systems)
C	OMRON Corp.: SYSBUS Wire System
D	SHARP Corp.: Satellite I/O Link System
F1	NKE Corp.: Uni-wire System (16 output points)
J1	SUNX Corp.: S-LINK System (16 output points)
J2	SUNX Corp.: S-LINK System (8 output points)
K	Fuji Electric Co.: T-LINK Mini System
Q	DeviceNet, CompoBus/D (OMRON Corp.)
R1	OMRON Corp.: CompoBus/S System (16 output points)
R2	OMRON Corp.: CompoBus/S System (8 output points)
U	JEMANET (JPCN-1)
V	Mitsubishi Electric Corp.: CC-LINK System
G	Rockwell Automation: Allen Bradley Remote I/O (RIO) System
H	NKE Corp.: Uni-wire H System

Symbol	Option
Nil	None
CD1 (2)	Exhaust cleaner for Rc 1: D side exhaust
CD2 (2)	Exhaust cleaner for Rc 11/2: D side exhaust
CU1 (2)	Exhaust cleaner for Rc 1: U side exhaust
CU2 (2)	Exhaust cleaner for Rc 11/2: U side exhaust
K (3)	Special wiring specifications (Except double wiring)
SD (2)	Direct exhaust with silencer box: D side exhaust
SU (2)	Direct exhaust with silencer box: U side exhaust
W	IP65 enclosure

Note 1) When two or more symbols are specified, indicate them alphabetically. Example) -CD1K.
Note 2) Combination of [C□□] and [S□] is not possible.
Note 3) Specify the wiring specifications on the manifold specification sheet.

SI unit mounting position

D	D side mounting
U	U side mounting

Plug-in Unit Series VQ5000

● Correspondence of SI unit output numbers and solenoid valve coils

Mixed wiring is available as an option.
Use the manifold specification sheet to specify.

<Wiring example 1> Double wiring (Standard)

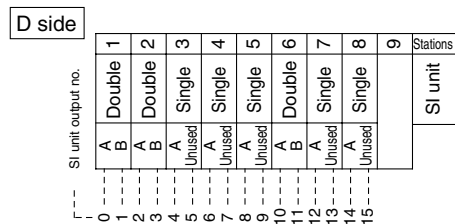

<Wiring example 2> Single/Double mixed wiring (Option)

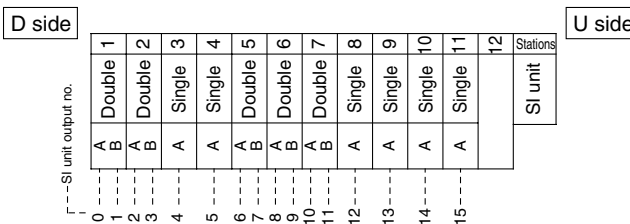

	Type SC OMRON Corporation SYSBUS Wire System	Type SD SHARP Corporation Satellite I/O Link System																
Name of terminal block (LED)																		
	<table border="1"> <thead> <tr> <th>LED</th> <th>Description</th> </tr> </thead> <tbody> <tr> <td>RUN</td> <td>Lights when transmission is normal and PLC is in operation mode</td> </tr> <tr> <td>T/R ERR</td> <td>Blinks during data transmission/reception ON when transmission is abnormal.</td> </tr> </tbody> </table>	LED	Description	RUN	Lights when transmission is normal and PLC is in operation mode	T/R ERR	Blinks during data transmission/reception ON when transmission is abnormal.	<table border="1"> <thead> <tr> <th>LED</th> <th>Description</th> </tr> </thead> <tbody> <tr> <td>POWER</td> <td>ON when power supply is ON</td> </tr> <tr> <td>RUN</td> <td>Lights when power is ON and slave stations are operating normally</td> </tr> <tr> <td>ERROR</td> <td>Lights when slave station switch setting is abnormal, communication is abnormal, PLC stopped and defective slave unit</td> </tr> <tr> <td>R.SET HOLD</td> <td>ON for master unit control input</td> </tr> </tbody> </table>	LED	Description	POWER	ON when power supply is ON	RUN	Lights when power is ON and slave stations are operating normally	ERROR	Lights when slave station switch setting is abnormal, communication is abnormal, PLC stopped and defective slave unit	R.SET HOLD	ON for master unit control input
	LED	Description																
RUN	Lights when transmission is normal and PLC is in operation mode																	
T/R ERR	Blinks during data transmission/reception ON when transmission is abnormal.																	
LED	Description																	
POWER	ON when power supply is ON																	
RUN	Lights when power is ON and slave stations are operating normally																	
ERROR	Lights when slave station switch setting is abnormal, communication is abnormal, PLC stopped and defective slave unit																	
R.SET HOLD	ON for master unit control input																	
Note	<ul style="list-style-type: none"> Master station unit OMRON PLC SYSMAC C(CV) series Types C500-RM201 and C200H-RM201 *32 units max., transmission terminal connection (512 points max.) No. of output points, 16 points 	<ul style="list-style-type: none"> Master station unit SHARP Corporation PLC New Satellite Series W ZW-31LM New Satellite Series JW JW-23LM, JW-31LM *Max. 31 units, I/O slave stations connected (504 points max.) No. of output points, 16 points 																

- VQC
- SQ
- VQ0
- VQ4
- VQ5
- VQZ
- VQD

How to Order Valves

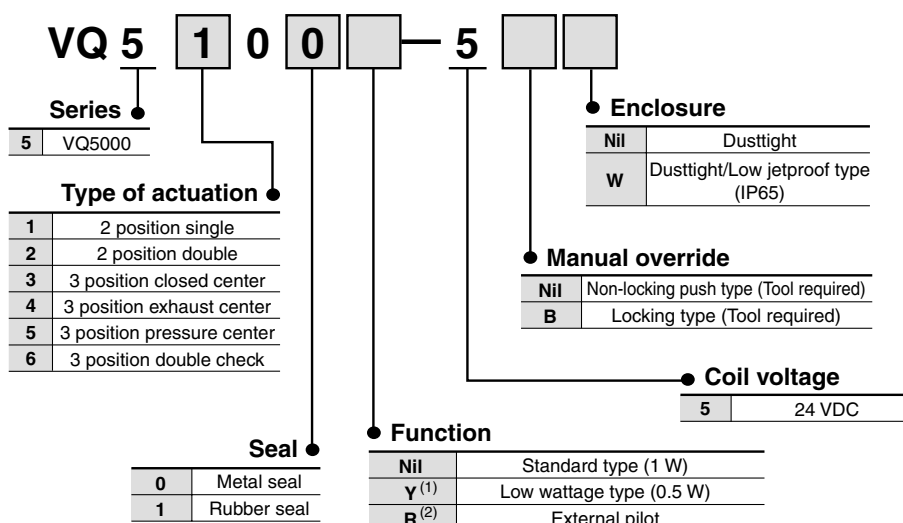

Note 1) Applicable to DC specification.
Note 2) Refer to page 2-6-39 for details on external pilot specifications.
Note 3) When two or more symbols are specified, indicate them alphabetically.

How to Order Manifold Assembly

Specify the part numbers for valves and options together beneath the manifold base part number.

<Example>
Serial transmission unit
VV5Q51-0603SUA ... 1 set —Manifold base part no.
*VQ5100-5 2 sets —Valve part no. (Stations 1 and 2)
*VQ5200-5 2 sets —Valve part no. (Stations 3 and 4)
*VQ5300-5 1 set —Valve part no. (Station 5)

Prefix the asterisk to the part nos. of the solenoid valve, etc.

Enter in order starting from the first station on the D side. When entry of part numbers becomes complicated, indicate in the manifold specification sheet.

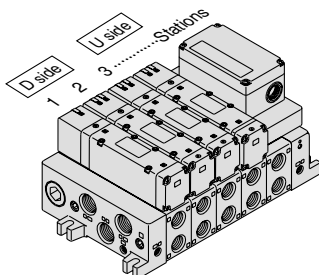

S

Kit (Serial transmission unit)

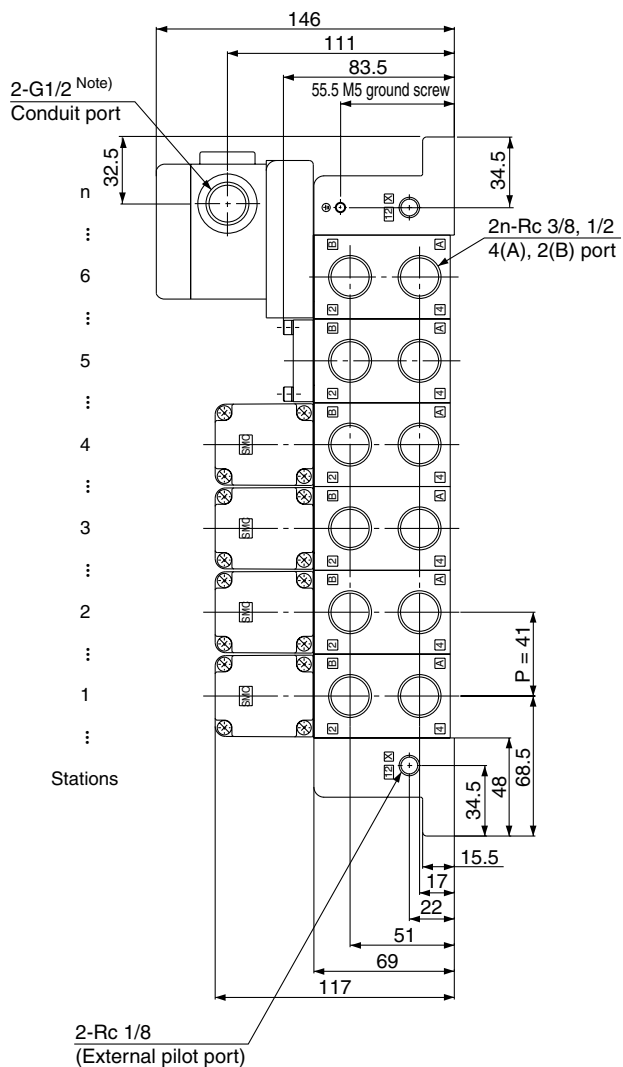
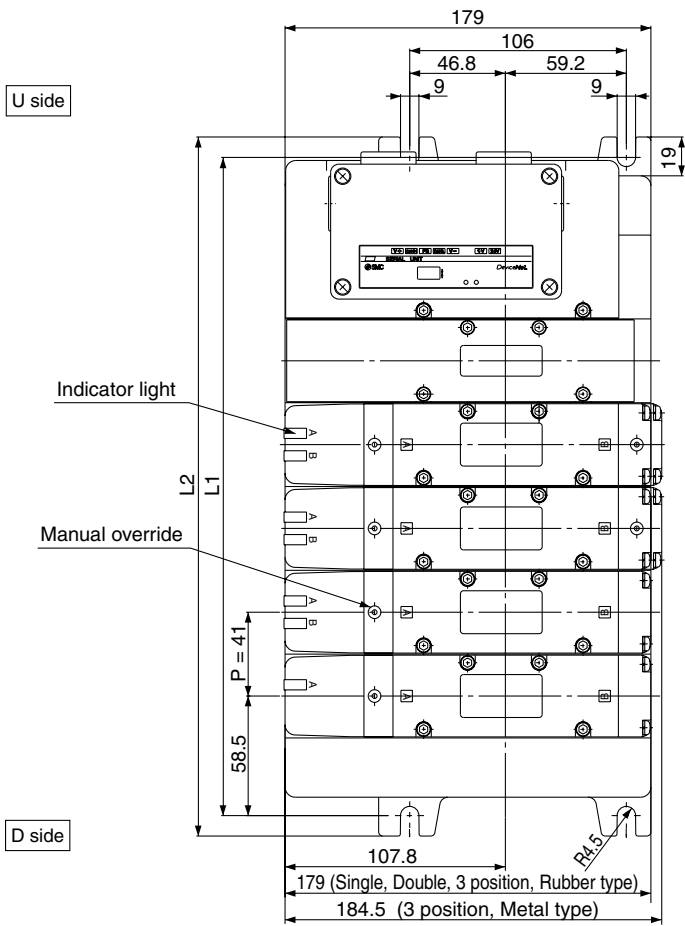
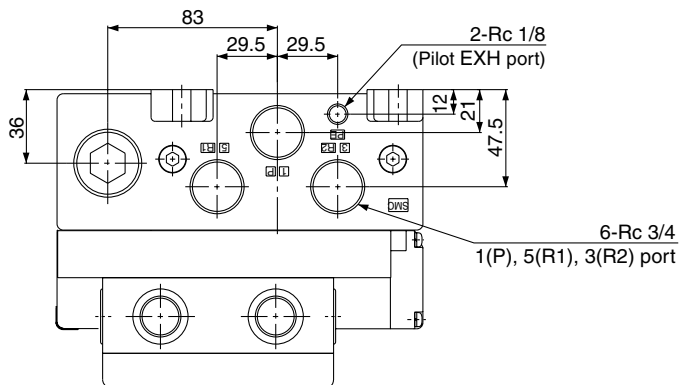

Note) In the case of two power supply systems (separate SI unit and solenoid drive power supplies), there are conduit ports (G 1/2) in four locations. Other models have conduit ports in two locations.

Plug-in Unit Series VQ5000

Bottom port drawing

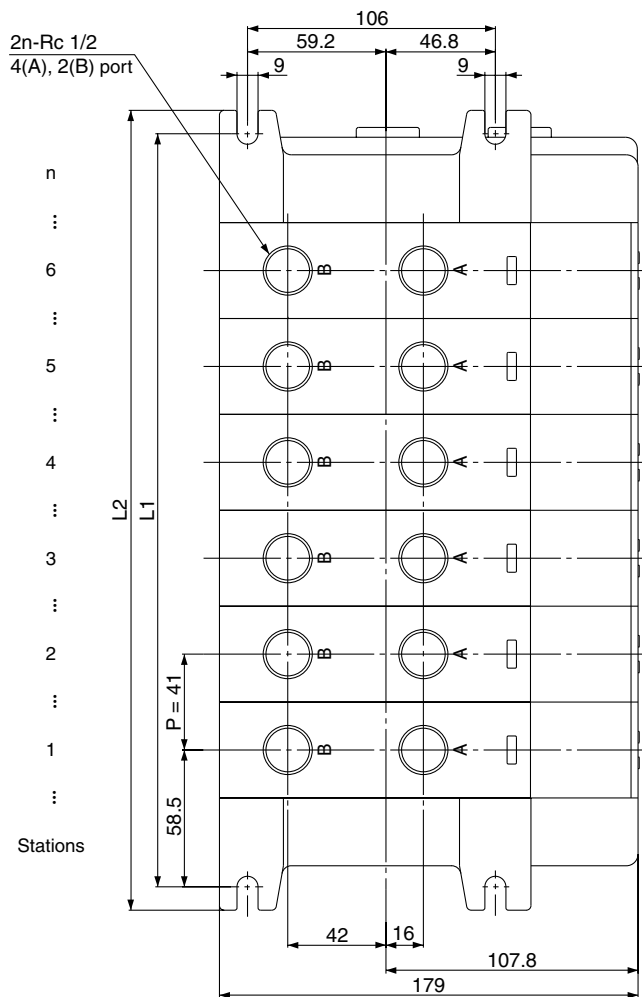
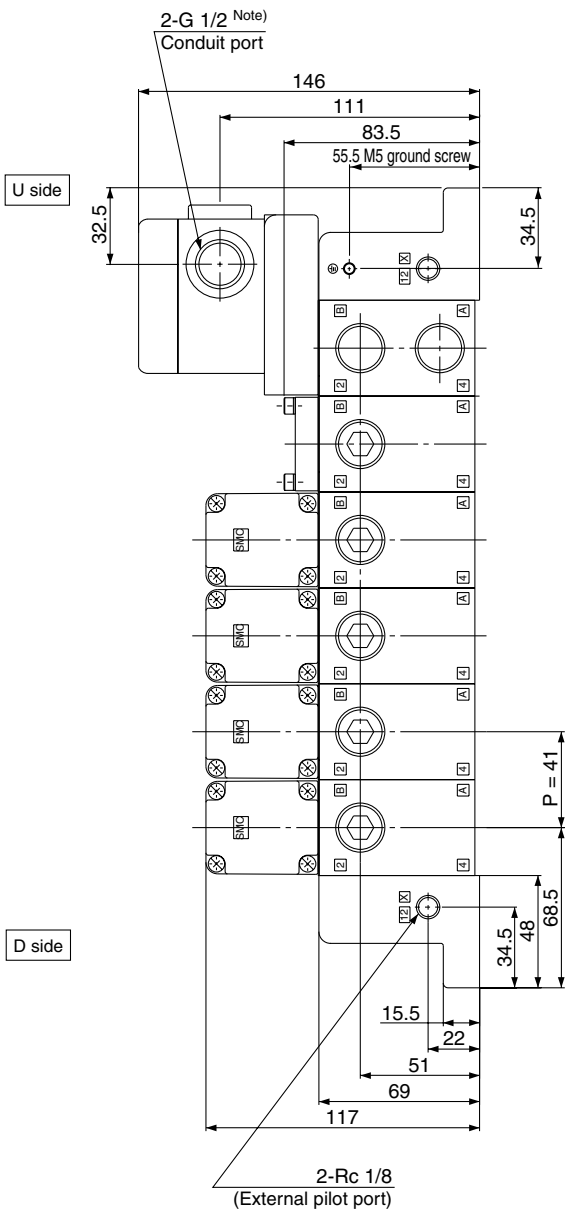

- VQC
- SQ
- VQ0
- VQ4
- VQ5**
- VQZ
- VQD

Formula: L1 = 41n + 76, L2 = 41n + 96
 n: Stations (Maximum 12 stations)
 * Including 1 station for SI unit box mounting

Dimensions

L \ n	2	3	4	5	6	7	8	9	10	11	12
L1	158	199	240	281	322	363	404	445	486	527	568
L2	178	219	260	301	342	383	424	465	506	547	588

Series VQ5000

Base Mounted

Plug Lead Unit: C Kit (Connector Kit)

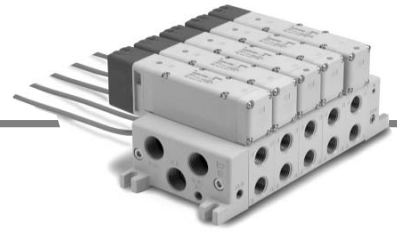

How to Order Manifold

VV5Q 5 5 - 08 03 C - W

Series

5	VQ5000
---	--------

Manifold

5	Plug lead unit
---	----------------

Stations

01	1 station
⋮	⋮
12	12 stations

Cylinder port

03	Rc 3/8
04	Rc 1/2
B	Bottom ported Rc 1/2
CM	Mixed

Kit type

C kit (Connector)

C	Connector kit	Max. 12 stations
---	---------------	------------------

Option

Symbol	Option
Nil	None
CD1 ^{Note}	Exhaust cleaner for Rc 1: D side exhaust
CD2 ^{Note}	Exhaust cleaner for Rc 1 1/2: D side exhaust
CU1 ^{Note}	Exhaust cleaner for Rc 1: U side exhaust
CU2 ^{Note}	Exhaust cleaner for Rc 1 1/2: U side exhaust
SB	Direct exhaust with silencer box: Exhaust from both U and D sides
SD ^{Note}	Direct exhaust with silencer box: D side exhaust
SU ^{Note}	Direct exhaust with silencer box: U side exhaust
W	IP65 enclosure

Note) Combination of [C_D^U] and [S_D^U] is not possible.

Refer to page 2-6-2 (Grommet style) for wiring specifications.

How to Order Valves

VQ 5 1 5 0 - 5 G

Series

5	VQ5000
---	--------

Type of actuation

1	2 position single
2	2 position double
3	3 position closed center
4	3 position exhaust center
5	3 position pressure center
6	3 position double check

Seal

0	Metal seal
1	Rubber seal

Function

Nil	Standard type (1 W)
Y ⁽¹⁾	Low wattage type (0.5 W)
R ⁽²⁾	External pilot

Note 1) Applicable to DC specification.
 Note 2) Refer to page 2-6-39 for details on external pilot specifications.
 Note 3) When two or more symbols are specified, indicate them alphabetically.

Coil voltage

1	100 VAC (50/60 Hz)	4	220 VAC (50/60 Hz)
2	200 VAC (50/60 Hz)	5	24 VDC
3	110 VAC (50/60 Hz)	6	12 VDC

Enclosure

Nil	Dusttight
W	Dusttight/Low jetproof type (IP65)

Manual override

Nil:	Non-locking push type (Tool required)
B:	Locking type (Tool required)

Light/Surge voltage suppressor

Nil	Yes
E	Without light, with surge voltage suppressor

Electrical entry

G	Lead wire length 0.6 m
H	Lead wire length 1.5 m

Grommet

How to Order Manifold Assembly

Specify the part numbers for valves and options together beneath the manifold base part number.

<Example> Connector kit

W5Q55-05042C-z-1 set — Manifold base part no.
 * VQ5150-5G 2 sets — Valve part no. (Stations 1 and 2)
 * VQ5250-5G 2 sets — Valve part no. (Stations 3 and 4)
 * VQ5350-5G 1 set — Valve part no. (Station 5)

Prefix the asterisk to the part nos. of the solenoid valve, etc.

Enter in order starting from the first station on the D side. When entry of part numbers becomes complicated, indicate in the manifold specification sheet.

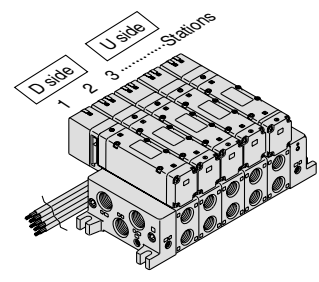

Plug Lead Unit Series VQ5000

Manifold Specifications

Series	Base model	Type of connection	Porting specifications			Maximum applicable stations	Applicable solenoid valve	5 station weight (kg)
			4(A), 2(B) port location	Port size ^{Note)}				
				1(P), 5(R1), 3(R2)	4(A), 2(B)			
VQ5000	VV5Q55-□□□	■ C kit-Grommet	Side Bottom	Rc 3/4 Option (Direct exhaust with silencer box)	Rc 3/8 Rc 1/2 Rc 1/2	2 to 12 stations	VQ5□50 VQ5□51	3.7 • Except solenoid valve weight

Note) For details about international standard threads other than Rc threads, refer to "Option" on page 2-6-39.

Flow Characteristics at the Number of Manifold Stations (Operated individually)

Model	Passage/Stations		Station 1	Station 5	Station 10
2 position metal seal VQ5 ₂ 100	1 → 4/2 (P → A/B)	C [dm ³ /(s-bar)]	11	11	11
		b	0.24	0.24	0.24
		Cv	2.7	2.7	2.7
	4/2 → 5/3 (A/B → EA/EB)	C [dm ³ /(s-bar)]	12	12	12
		b	0.14	0.14	0.14
		Cv	2.9	2.9	2.9
2 position rubber seal VQ5 ₂ 01	1 → 4/2 (→ RA/B)	C [dm ³ /(s-bar)]	12	12	12
		b	0.33	0.33	0.33
		Cv	3.4	3.4	3.4
	4/2 → 5/3 (A/B → EA/EB)	C [dm ³ /(s-bar)]	16	16	16
		b	0.33	0.33	0.33
		Cv	4.4	4.4	4.4

Note) For port size Rc 1/2

Manifold Option

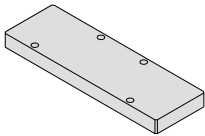
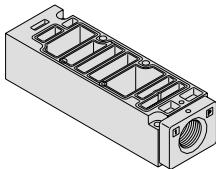
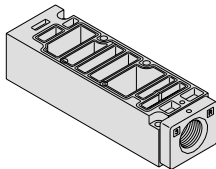
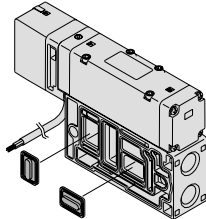
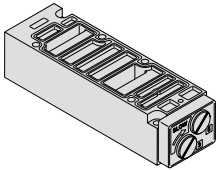
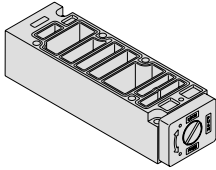
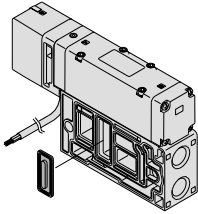
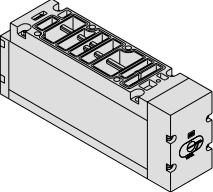
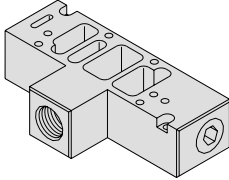
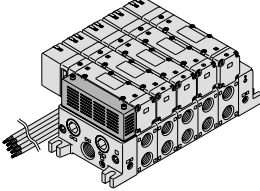
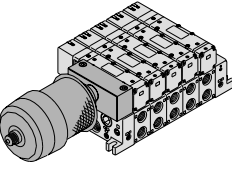
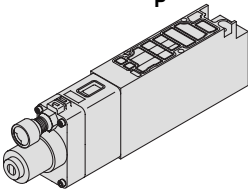
<p>Blanking plate assembly VVQ5000-10A-5</p> 	<p>Individual SUP spacer VVQ5000-P-5-⁰³/₀₄</p> 	<p>Individual EXH spacer VVQ5000-R-5-⁰³/₀₄</p> 	<p>EXH block plate VVQ5000-16A-2</p> 
<p>Throttle valve spacer VVQ5000-20A-5</p> 	<p>SUP stop valve spacer VVQ5000-37A-5</p> 	<p>SUP block plate VVQ5000-16A-1</p> 	<p>Double check spacer with residual pressure release valve VVQ5000-25A-5</p> 
<p>Release valve spacer VVQ5000-24A-5D</p> 	<p>Direct exhaust with silencerbox [-S□]</p> 	<p>For exhaust cleaner mounting [-C□□]</p> 	<p>Interface regulator ARBQ5000-00-^A/_P-5</p> 

Refer to pages 2-6-34 to 2-6-39 for detailed dimensions of each option.
For replacement parts, refer to page 2-6-43.



VQC

SQ

VQ0

VQ4

VQ5

VQZ

VQD

C Kit (Connector)

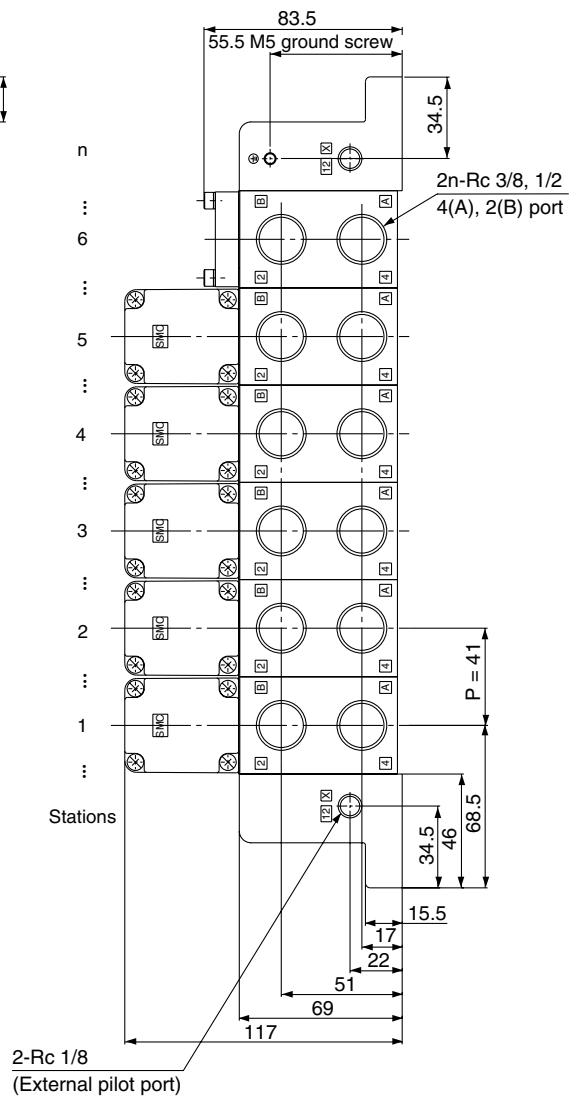
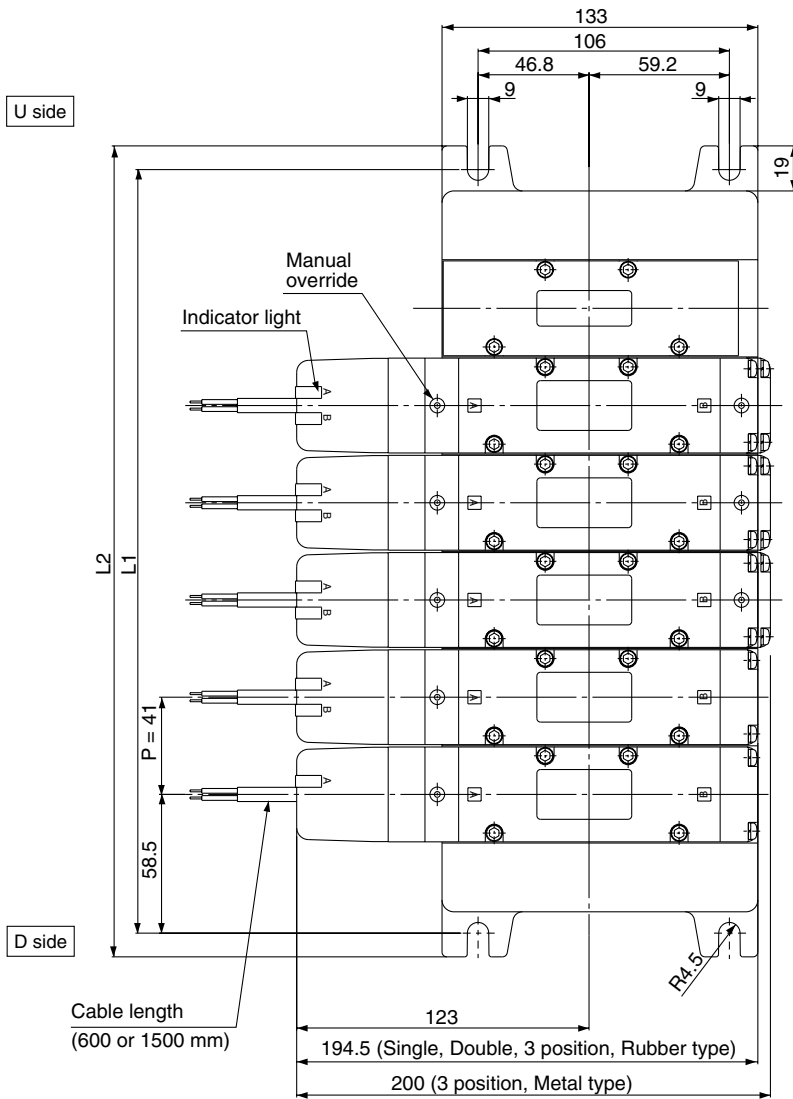
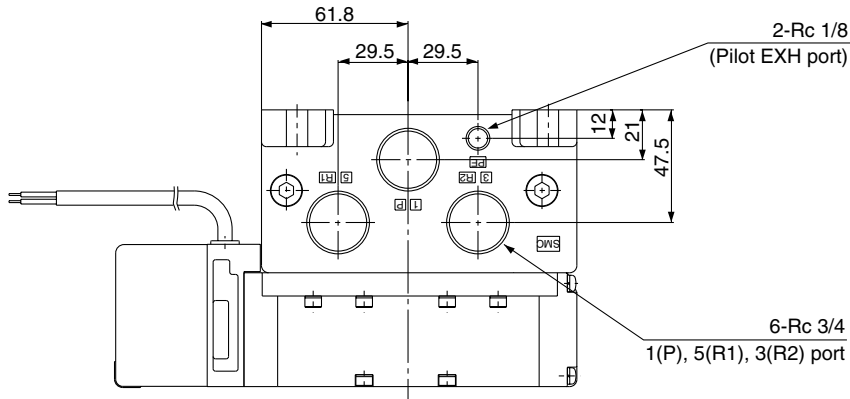

Plug Lead Unit Series VQ5000

Bottom ported drawing

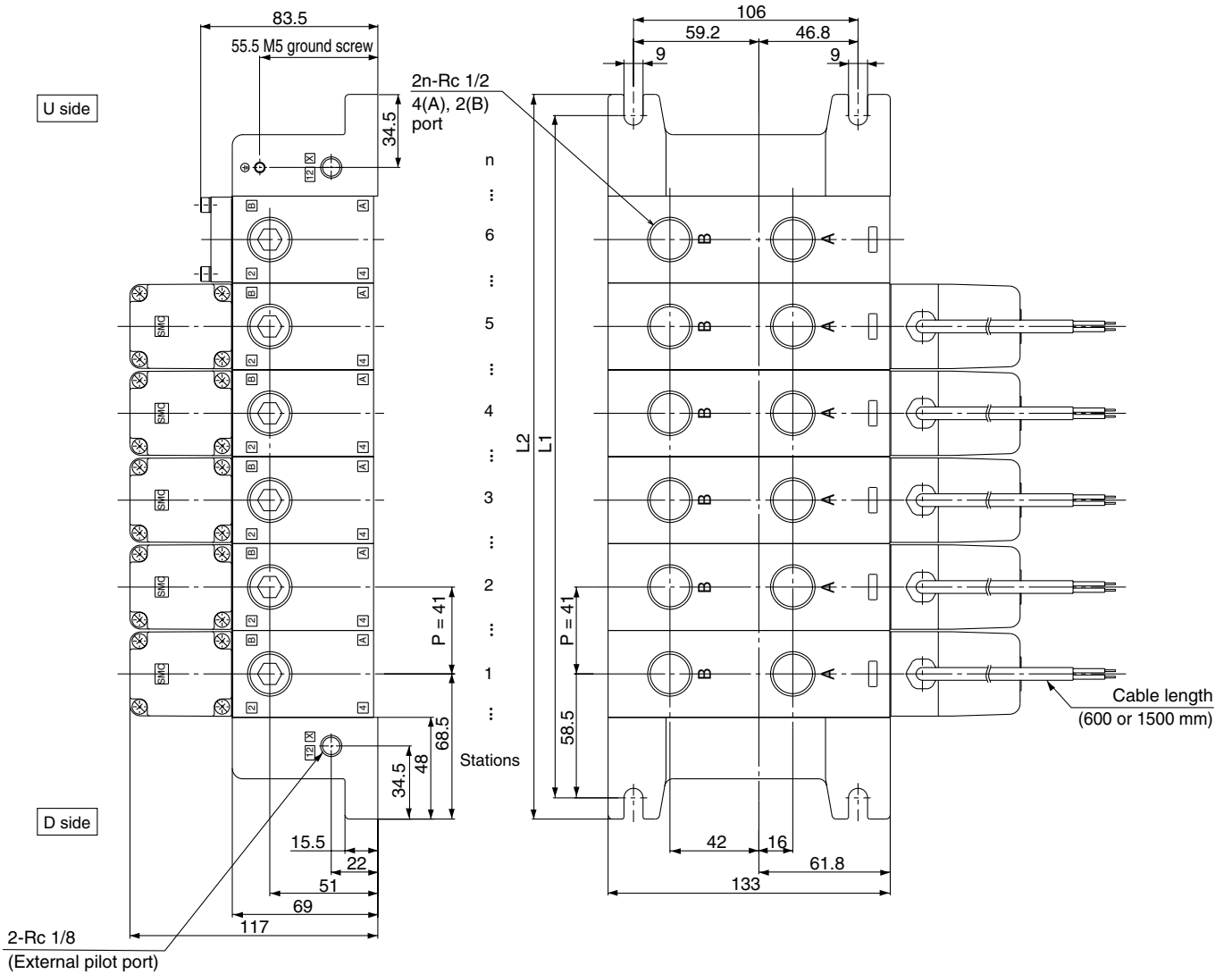

- VQC
- SQ
- VQ0
- VQ4
- VQ5**
- VQZ
- VQD

Formula: $L_1 = 41n + 76$, $L_2 = 41n + 96$
n: Stations (Maximum 12 stations)

L \ n	1	2	3	4	5	6	7	8	9	10	11	12
L1	117	158	199	240	281	322	363	404	445	486	527	568
L2	137	178	219	260	301	342	383	424	465	506	547	588

Series VQ5000

Manifold Option Parts

Blanking plate assembly

- VVQ5000-10A-1 (Plug-in type)
- VVQ5000-10A-5 (Plug lead type)

It is used by attaching on the manifold block for being prepared for removing a valve for maintenance reasons or planning to mount a spare valve, etc.

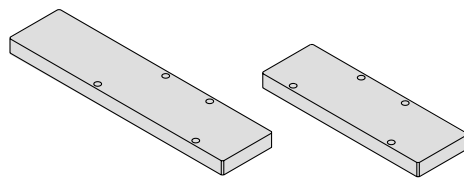

Plug-in type

Plug lead type

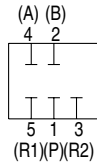

Circuit diagram

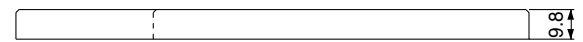
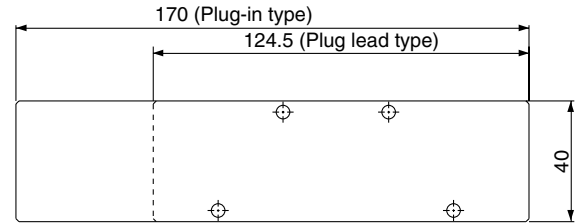

Individual SUP spacer

- VVQ5000-P-1-03/04 (Plug-in type)
- VVQ5000-P-5-03/04 (Plug lead type)

By mounting individual SUP spacers on a manifold block, it is possible to provide individual supply ports for each valve.

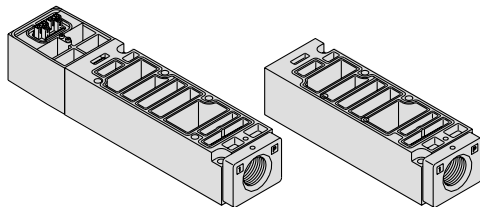

Plug-in type

Plug lead type

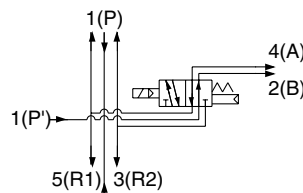

Circuit diagram

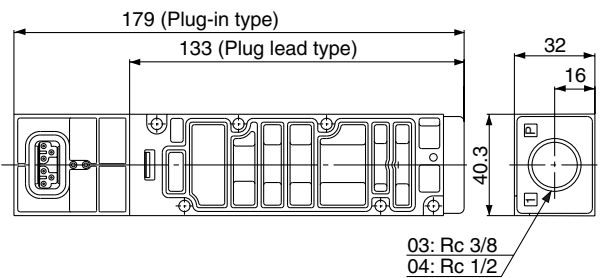

Individual EXH spacer

- VVQ5000-R-1-03/04 (Plug-in type)
- VVQ5000-R-5-03/04 (Plug lead type)

By mounting individual EXH spacers on a manifold block, exhaust ports can be provided individually for each valve. (Common EXH type)

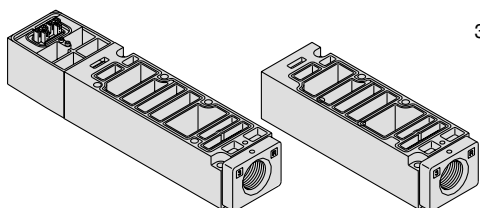

Plug-in type

Plug lead type

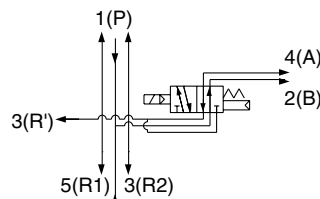

Circuit diagram

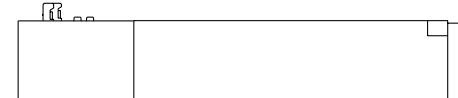
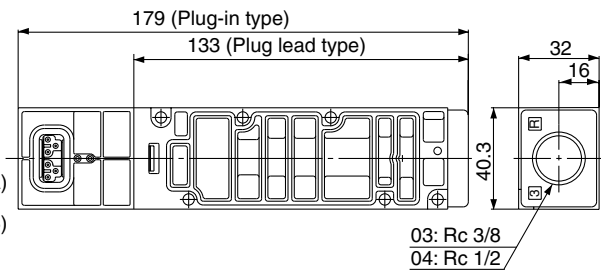

Series VQ5000

Throttle valve spacer

VVQ5000-20A-1 (Plug-in type)
VVQ5000-20A-5 (Plug lead type)

A throttle valve spacer is mounted on a manifold block to control cylinder speed by throttling exhaust air flow.

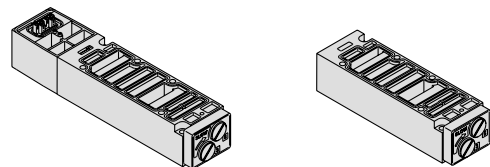

Plug-in type

Plug lead type

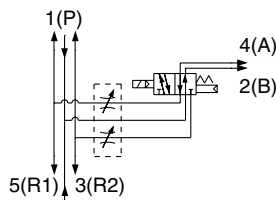

Circuit diagram

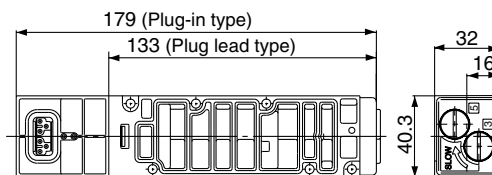

SUP stop valve spacer

VVQ5000-37A-1 (Plug-in type)
VVQ5000-37A-5 (Plug lead type)

A SUP stop valve spacer is mounted on a manifold block, making it possible to individually shut off supply air to each valve.

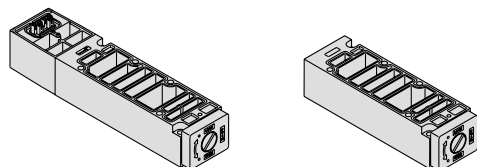

Plug-in type

Plug lead type

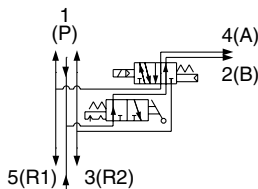

Circuit diagram

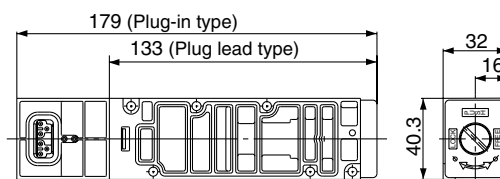

Release valve spacer: For D side mounting

VVQ5000-24A-1D (Plug-in type)
VVQ5000-24A-5D (Plug lead type)

A VQ51□□ (single) valve can be used as an air release valve by combining it with a release valve spacer.
Note) 2 position double and 3 position cannot be mounted.

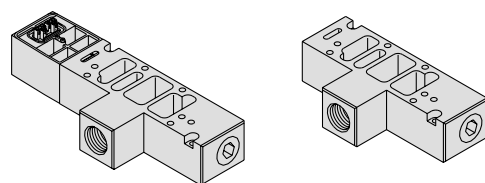

Plug-in type

Plug lead type

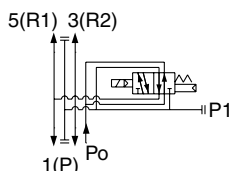

Circuit diagram

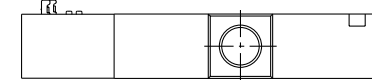
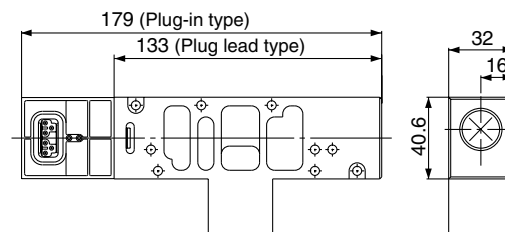

SUP block plate

VVQ5000-16A-1

EXH block plate

VVQ5000-16A-2

When different pressures, high and low, are supplied to manifold, a SUP block plate is inserted between the stations under different pressures.

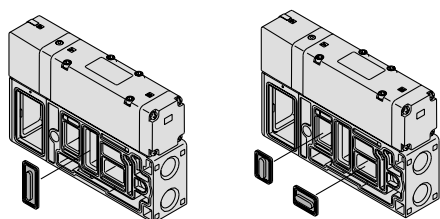

< SUP blocking plate >

< EXH blocking plate >

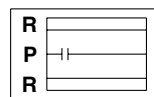
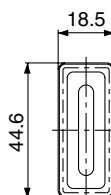

SUP passage blocked

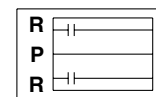
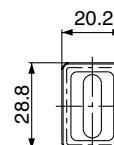

EXH passage blocked

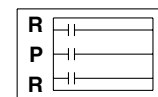

SUP/EXH passage blocked

VQC

SQ

VQ0

VQ4

VQ5

VQZ

VQD

Series VQ5000

Manifold Option Parts

Double check spacer with residual pressure release valve

VVQ5000-25A-1 (Plug-in type)
VVQ5000-25A-5 (Plug lead type)

Can hold an intermediate cylinder position for an extended time.

When combined with a double check spacer with built-in double check valve, it is unaffected by air leakage between the spool valves, making it possible to hold a cylinder at an intermediate stopping position for an extended time.

Further, a combination of a 2 position type (VQ5₂ □□) and a double check spacer can be used for drop prevention.

Plug-in type

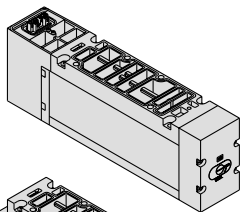

Plug lead type

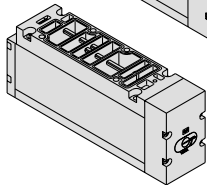

Specifications

Double check spacer part no.	VVQ5000-25A- ₁ / ₅			
	Intermediate stop	Drop prevention		
Applicable solenoid valve	VQ54□□	VQ5 ₂ □□		
Leakage N cm ³ /min	One solenoid energized	1(P)	5 (R1) 3 (R2)	320 or less
		Both solenoids unenergized	1(P)	5 (R1) 3 (R2)
			4(A)	5 (R1)
		2(B)	3 (R2)	

* Supply pressure: 0.5 MPa

Caution

Handling Precautions

- In the case of 3 position double check (VZS65₃□□), check the leakage from piping and fittings in between valve and cylinder by means of synthetic detergent solutions, and ensure that there is no such leakage found there. Also check the leakage from cylinder seal and piston seal. If there is any leakage, sometimes the cylinder, when valve is de-energized, can move without stopping at intermediate position.
- Use caution, as excessive throttling of the double check spacer exhaust can cause a loss of intermediate stopping accuracy and malfunction.
- Combination with a 3 position VQ5₃□□ is not possible.
- Set the cylinder load so that the cylinder pressure will be within two times that of the supply pressure.

Direct exhaust with silencer box

VV5Q5₁-□□□-SD (D side exhaust)
VV5Q5₁-□□□-SU (U side exhaust)
VV5Q5₁-□□□-SB (Double side exhaust)

The EXH outlet is placed on the top side of the manifold end plate. The built-in silencer provides highly effective noise reduction. (Noise reduction of 35 dB or more)

Note) Note that when excessive drainage occurs in the air supply, the drainage will be released along with the exhaust.

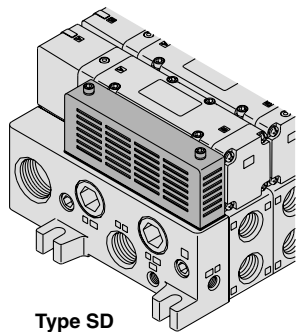
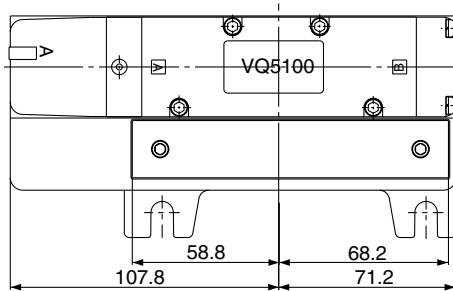

Type SD

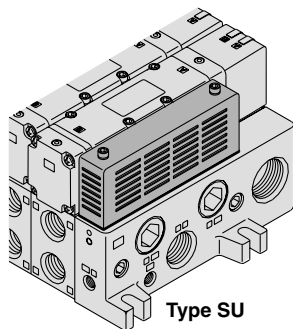

Type SU

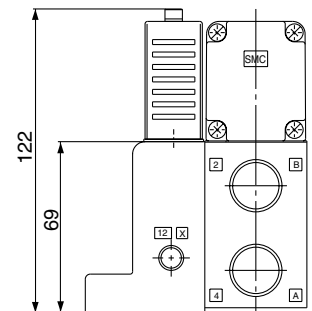
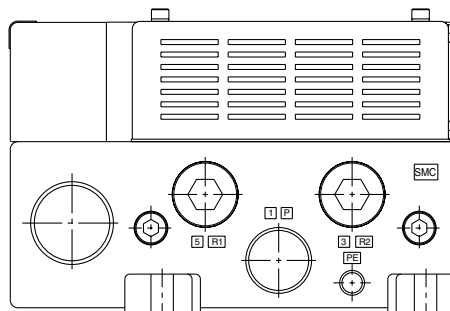

Note) The drawing shows a VV5Q51-□□□-SD.

Series VQ5000

Manifold mounted exhaust cleaner

VV5Q5¹-□□□-CD (D side mounting)
 VV5Q5¹-□□□-CU (U side mounting)

An adapter plate for exhaust cleaner mounting is provided on the top of the manifold end plate. The exhaust cleaner collects drainage and oil mist (99.9% or more) and is highly effective for noise reduction. (Noise reduction of 35 dB or more)

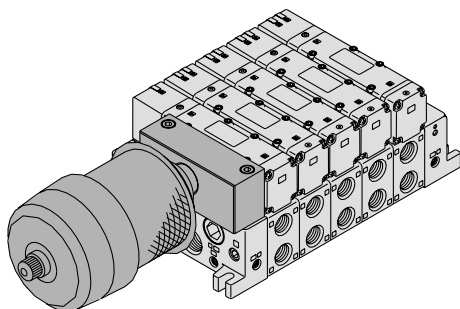

Applicable exhaust cleaners

AMC610-10 (Port size Rc 1), AMC810-14 (Port size Rc 1 1/2)

- Note 1) Exhaust cleaner: AMC610-10 and MC810-14 are not included. (Order separately)
- Note 2) Mount so that the exhaust cleaner is at the lower side.
- Note 3) For details about the exhaust cleaner, refer to Best Pneumatics vol.5.

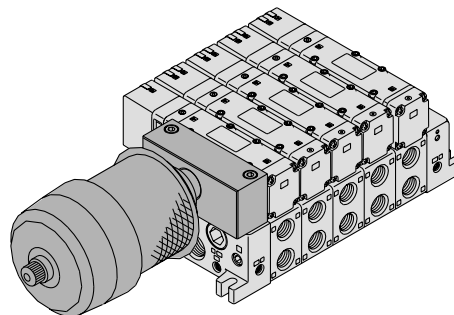

- VQC
- SQ
- VQ0
- VQ4
- VQ5
- VQZ
- VQD

Plug-in type

Plug lead type

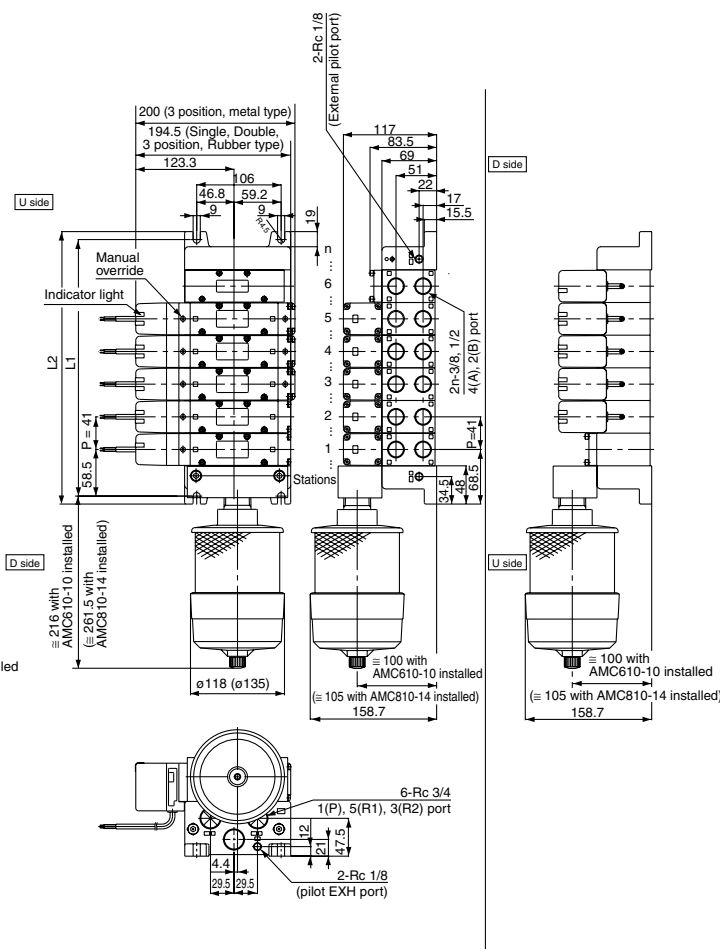
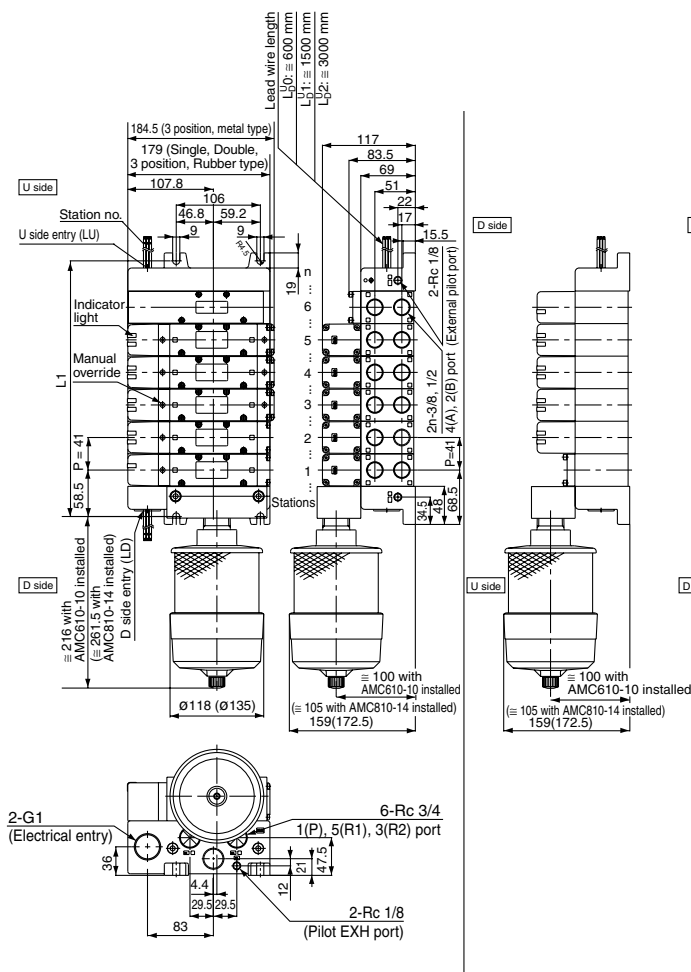

Formula: $L1 = 41n + 76$, $L2 = 41n + 96$
 n: Stations (Maximum 12 stations)

L	n	2	3	4	5	6	7	8	9	10	11	12
L1		158	199	240	281	322	363	404	445	486	527	568
L2		178	219	260	301	342	383	424	465	506	547	588

Formula: $L1 = 41n + 76$, $L2 = 41n + 96$
 n: Stations (Maximum 12 stations)

L	n	2	3	4	5	6	7	8	9	10	11	12
L1		158	199	240	281	322	363	404	445	486	527	568
L2		178	219	260	301	342	383	424	465	506	547	588

Series VQ5000

Manifold Option Parts

Interface regulator (P, A, B port regulation)

ARBQ5000-00-□-1 (Plug-in type)

ARBQ5000-00-□-5 (Plug lead type)

By mounting a spacer regulator on the manifold block, it enables to regulate pressure per every valve.

Specifications

Interface regulator		ARBQ5000					
Regulating port		A		B		P	
Applicable solenoid valve		Plug-in	Plug lead	Plug-in	Plug lead	Plug-in	Plug lead
Maximum operating pressure		1.0 MPa					
Set pressure range		0.05 to 0.85 MPa					
Fluid		Air					
Ambient and fluid temperature		-5 to 60°C (No freezing)					
Port size for connection of pressure gauge		M5 x 0.8					
Weight (kg)		0.79	0.74	0.78	0.73	0.79	0.74
Effective area at supply side (mm ²) S at P1 = 0.7 MPa/P2 = 0.5 MPa	P → A	33		75		29	
	P → B	64		33		28	
Effective area at exhaust side (mm ²) S at P2 = 0.5 MPa	A → EA	36		75		78	
	B → EB	68		38		69	



Note 1) Set the pressure within the operating pressure range of the solenoid valve.

Note 2) Use a spacer regulator by pressurizing from the P port on the base except the case of being used as a dual pressure valve. Besides, P port regulation is not allowed to use.

Note 3) When using a perfect spacer, assemble a valve, a spacer regulator and a perfect spacer in this order to use it.

Note 4) When using in A port regulation, B port regulation by closed center, since there is a problem in its operation, please contact SMC.

Note 5) Dusttight/splash proof enclosure (IP65) is not available with interface regulator.

How to Order

Solenoid valve	Interface regulator	Regulating port
VQ5□□ (Plug-in type)	ARBQ5000-00-A-1	A
	ARBQ5000-00-B-1	B
	ARBQ5000-00-P-1	P
VQ5□5□ (Plug lead type)	ARBQ5000-00-A-5	A
	ARBQ5000-00-B-5	B
	ARBQ5000-00-P-5	P

Dimensions

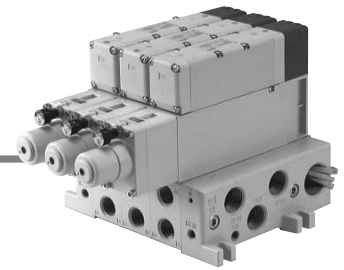
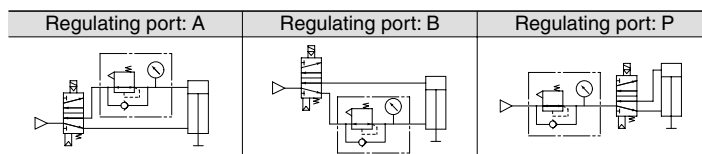
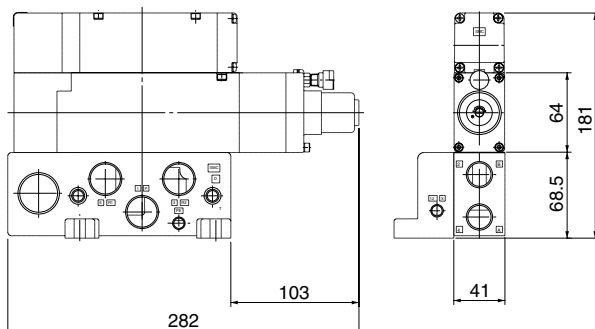

Flow Characteristics

Conditions Inlet pressure: 0.7 MPa

ARBQ5000-00-A (P → A)

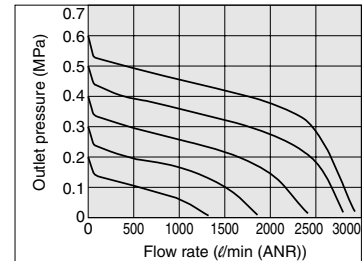

ARBQ5000-00-B (P → B)

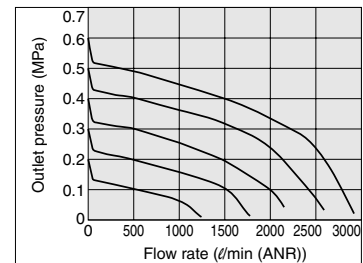

ARBQ5000-00-P (P → A)

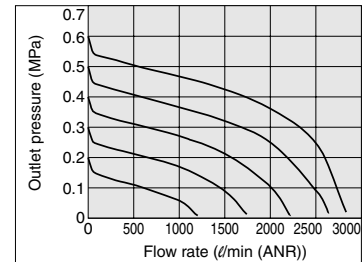

ARBQ5000-00-P (P → B)

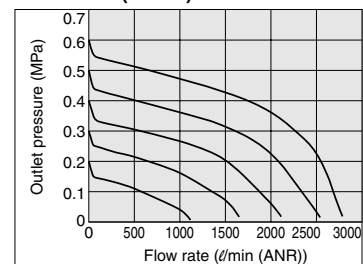

Pressure Characteristics

Conditions

Inlet pressure: 0.7 MPa

Outlet pressure: 0.2 MPa

Flow rate: 20 l/min(ANR)

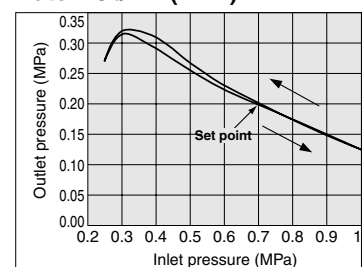

Option

External Pilot Specifications

When the supply pressure is

- lower than the minimum solenoid valve operating pressure of 0.1 to 0.2 MPa, or when it drops below this level,
- used for reverse pressure (R port pressure) or cylinder pressure (A, B port pressure),
- used for vacuum specifications (please contact SMC), it can be used for external pilot specifications.

Order a valve by adding the external pilot specification [R] to the part number.

External pilot is available as standard for manifolds and options.

How to Order Manifold

VQ5100 **R** — 5 — 04

● External pilot specifications

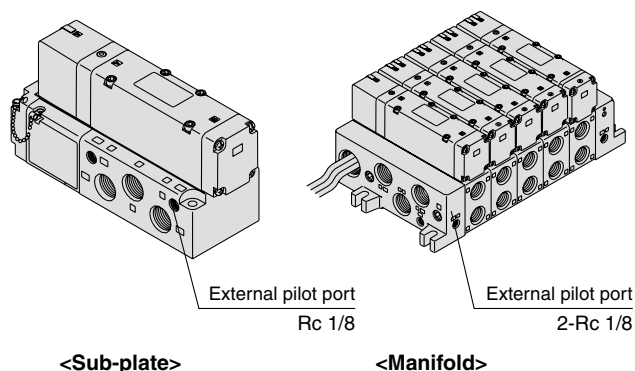

Note) Mixed mounting of internal and external pilots is possible

Pressure Specifications

Valve construction		Metal seal	Rubber seal
Operating pressure range		Vacuum to 1.0 MPa	
External pilot ^{Note)} pressure range	Single	0.1 to 1.0 MPa (0.1 to 0.7 MPa)	0.2 to 1.0 MPa (0.2 to 0.7 MPa)
	Double		0.15 to 1.0 MPa (0.15 to 0.7 MPa)
	3 position	0.15 to 1.0 MPa (0.15 to 0.7 MPa)	0.2 to 1.0 MPa (0.2 to 0.7 MPa)

Note) Values inside () denote the low wattage (0.5 W) specifications.

International Thread Standards Other than Rc

Rc specifications are standard for all ports, however, NPT, NPTF and G are available for international markets.

Add the appropriate symbol following the port size in the standard part number.

How to Order Single Valves (Example)

VQ5100 — 5 — 04

● Cylinder port
● Port size

● Thread type
1(P), 5(R1), 3(R2) and 4(A),
2(B) port

Nil	Rc
N	NPT
T	NPTF
F	G

How to Order Manifold

VV5Q51 — 08 — 03 FU1

● Cylinder port
● Port size

● Thread type
1(P), 5(R1), 3(R2) and 4(A),
2(B) port

Nil	Rc
N	NPT
T	NPTF
F	G

How to Order Sub-plates and Options (Example)

VQ5000 — P — B 04 (Sub-plate)

VVQ5000 — P — 1 — 04 (Option)

● Port size

● Thread type

Nil	Rc
N	NPT
T	NPTF
F	G

VQC

SQ

VQ0

VQ4

VQ5

VQZ

VQD

Series VQ5000 Construction

Plug-in Unit

Metal seal

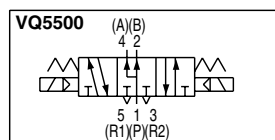
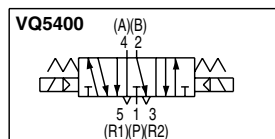
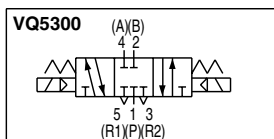
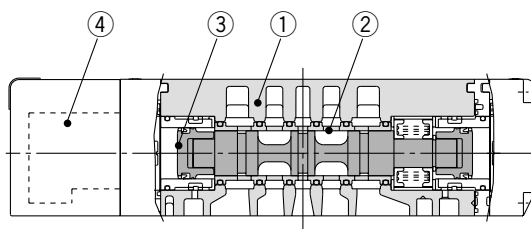
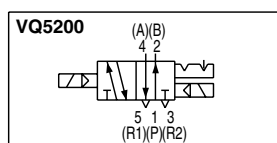
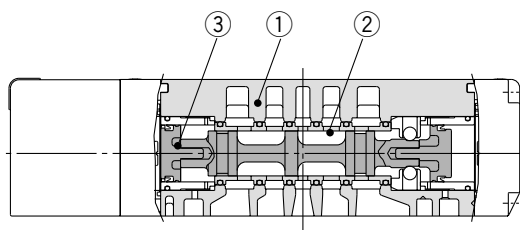
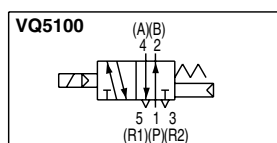
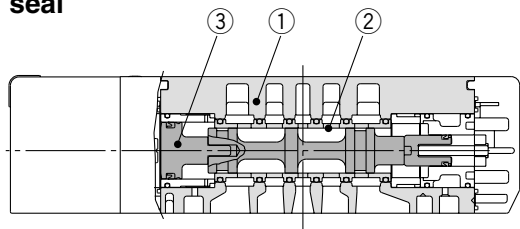

Rubber seal type

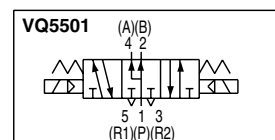
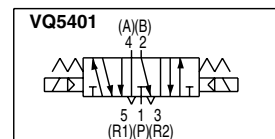
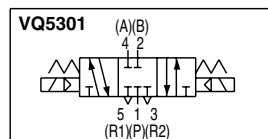
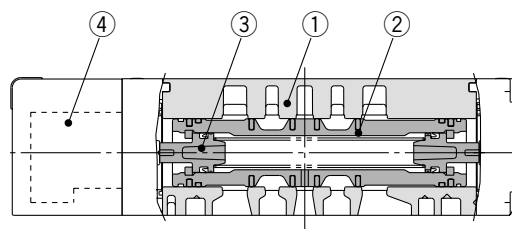
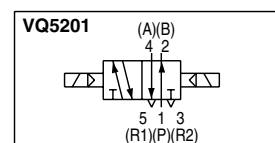
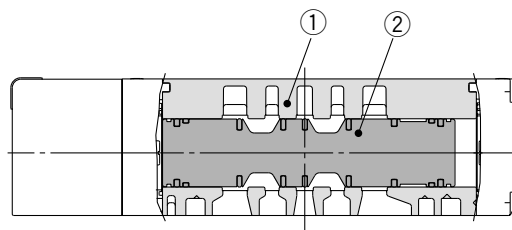
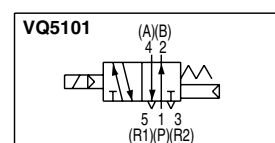
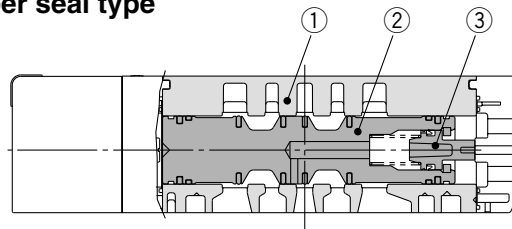

Component Parts

Number	Description	Material	Note
①	Body	Aluminum die-casted	
②	Spool/Sleeve	Stainless steel	
③	Piston	Resin	

Replacement Parts

④	Pilot valve assembly	VQZ111P-□	* Coil rated voltage Example) 24 VDC: 5
---	----------------------	-----------	--

Component Parts

Number	Description	Material	Note
①	Body	Aluminum die-casted	
②	Spool valve	Aluminum, NBR	
③	Piston	Resin	

Replacement Parts

④	Pilot valve assembly	VQZ111P-□	* Coil rated voltage Example) 24 VDC: 5
---	----------------------	-----------	--

Series VQ5000 Construction

Plug Lead Unit

Metal seal

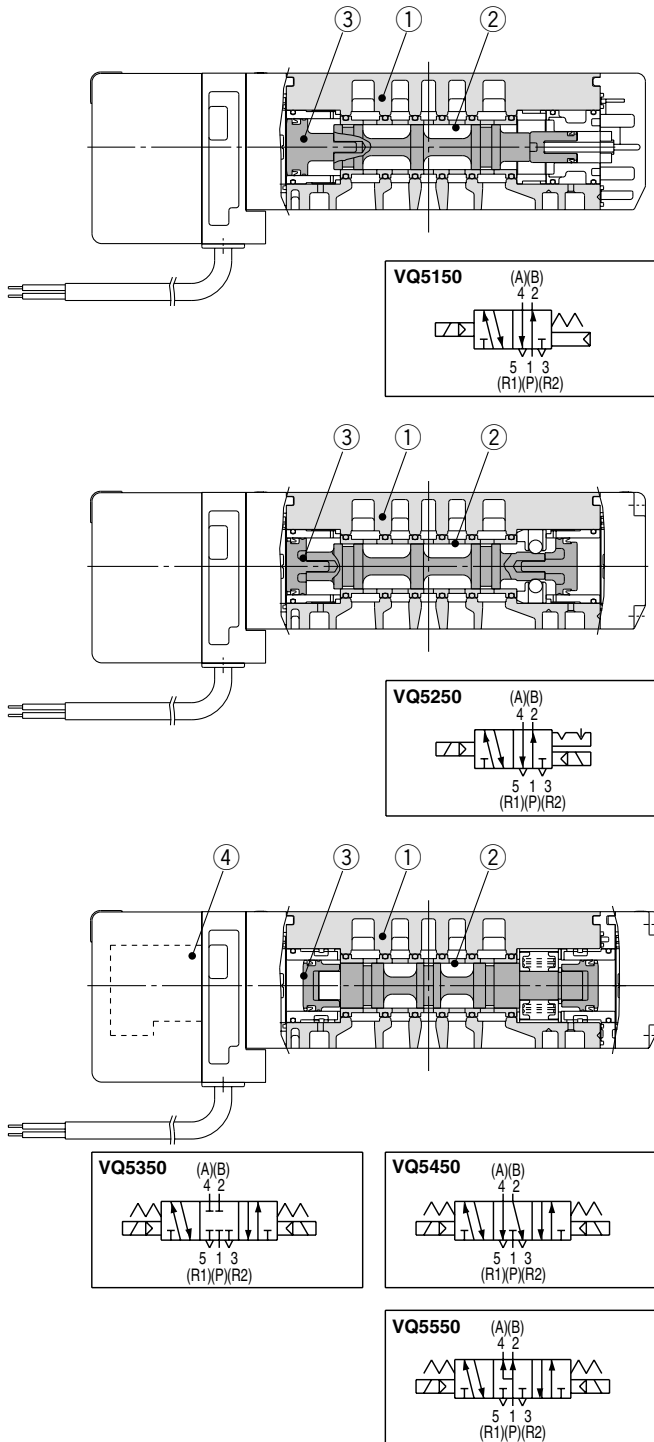

Component Parts

Number	Description	Material	Note
①	Body	Aluminum die-casted	
②	Spool/Sleeve	Stainless steel	
③	Piston	Resin	

Replacement Parts

④	Pilot valve assembly	VQZ111P-□	* Coil rated voltage Example) 24 VDC: 5
---	----------------------	-----------	--

Rubber seal type

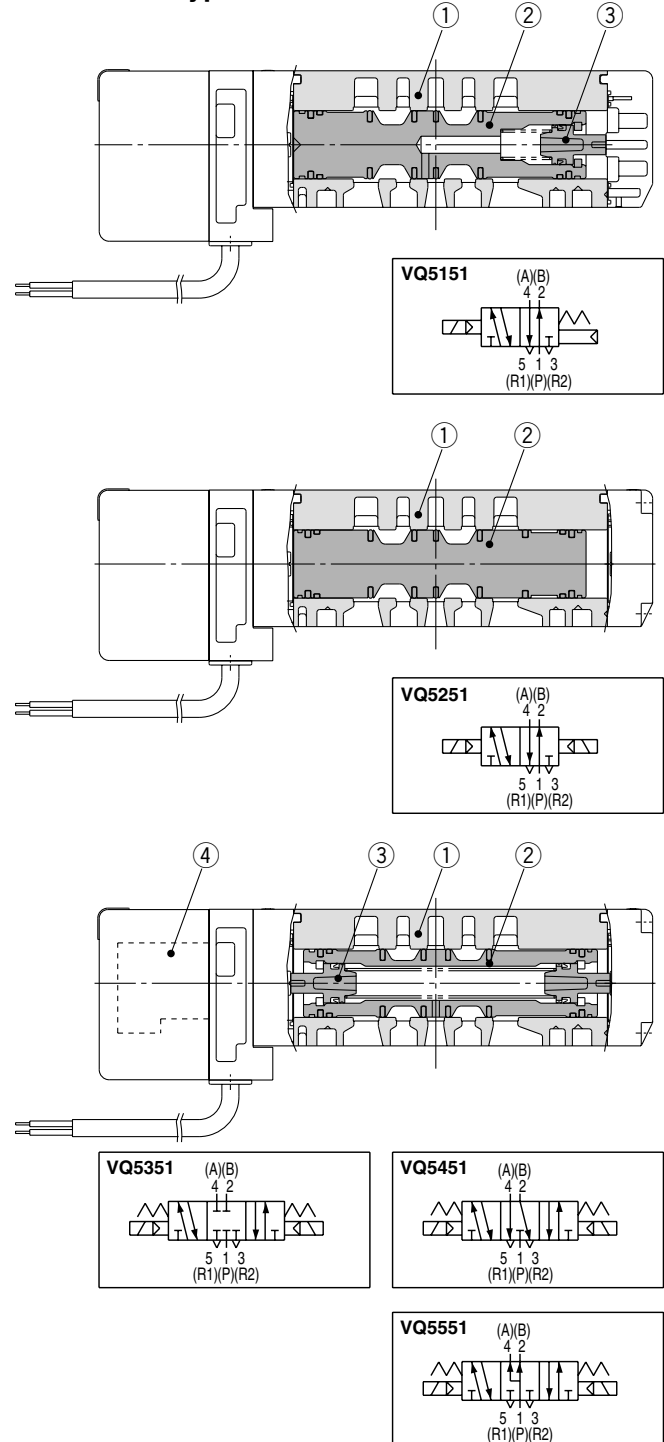

Component Parts

Number	Description	Material	Note
①	Body	Aluminum die-casted	
②	Spool valve	Aluminum, NBR	
③	Piston	Resin	

Replacement Parts

④	Pilot valve assembly	VQZ111P-□	* Coil rated voltage Example) 24 VDC: 5
---	----------------------	-----------	--

- VQC
- SQ
- VQ0
- VQ4
- VQ5**
- VQZ
- VQD

Series VQ5000

Exploded View of Manifold

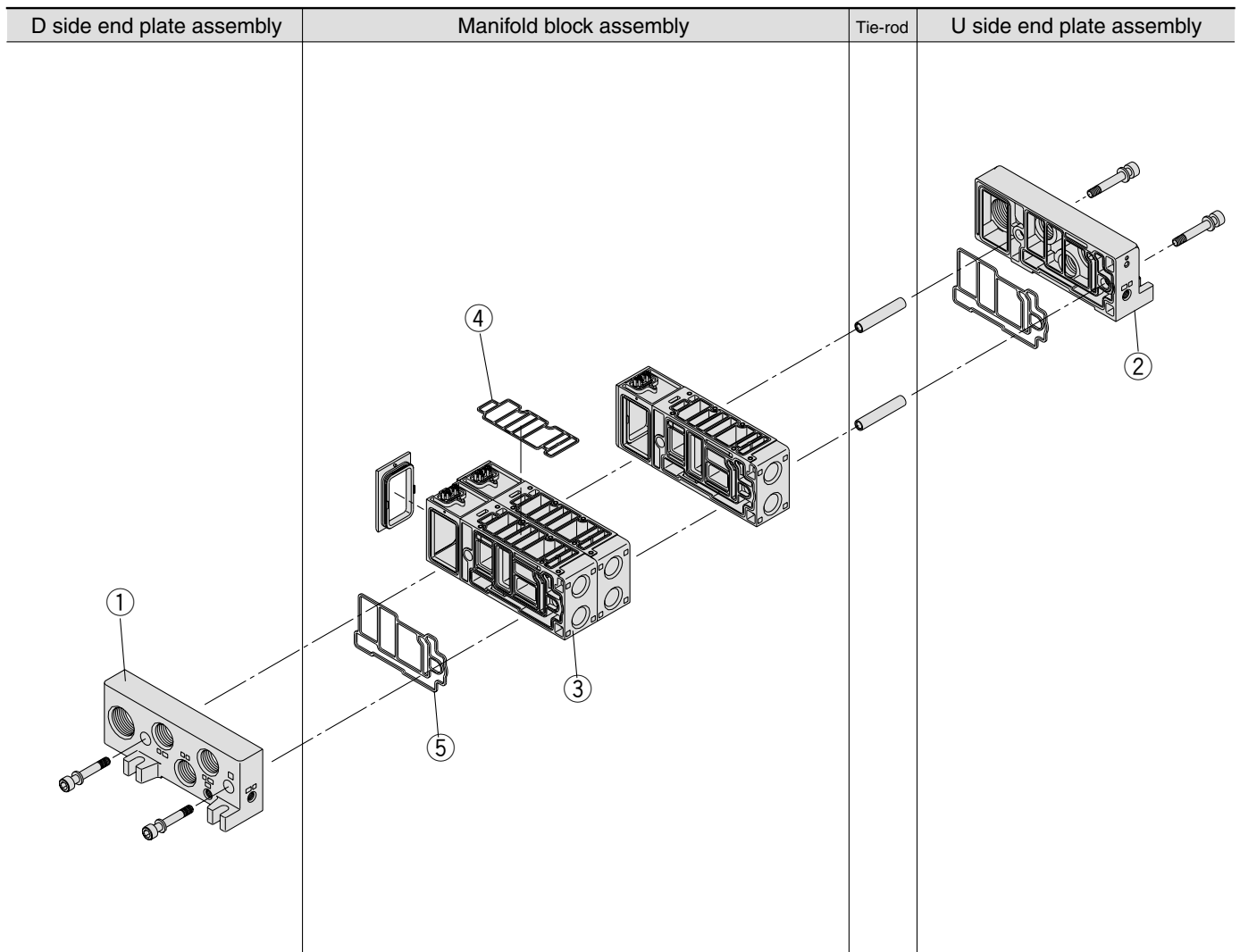

Note) The electrical entry cannot be changed.

The drawing shows a plug-in type.

Exploded View of Manifold Series VQ5000

<D Side End Plate Assembly>

1. D side end plate assembly part no. (for F, L, S, T & T1 kits)

VVQ5000 — 3A — 1

Electrical entry

L	T1, F, L, T, S kits
F ⁽¹⁾	F kit (Connector side)
C	C kit (plug lead type)

Option

Nil	Standard
W ⁽²⁾	IP65 enclosure is dust
CD1	Exhaust cleaner mounting Rc 1
CD2	Exhaust cleaner mounting Rc 1 1/2
SD	Direct exhaust with silencer box

Note 1) D-sub connector is not included.
Note 2) Splashproof specifications is not available for F and T1.

<U Side End Plate Assembly Part No.>

2. U side end plate assembly part no. (for F, L, S, T & T1 kits)

VVQ5000 — 2A — 1

Electrical entry

L	T1, F, L, T, S kits
F ⁽¹⁾	F kit (Connector side)
C	C kit (plug lead type)

Option

Nil	Standard
W ⁽²⁾	IP65 enclosure is dust
CU1	Exhaust cleaner mounting Rc 1
CU2	Exhaust cleaner mounting Rc 1 1/2
SU	Direct exhaust with silencer box

Note 1) D-sub connector is not included.
Note 2) Splashproof specifications is not available for F and T1.

<Manifold Block Assembly>

3. Manifold block assembly part no.

VVQ5000 — 1

Type

A	For 1 station
---	---------------

Option

Nil	Standard
W ⁽²⁾	Enclosure IP65 compliant

Electrical entry

F1	F kit Double wiring
F2	F kit Single wiring
T0	T1 kit (Individual terminal block) Double wiring
T1	T kit (Terminal box) Double wiring
T2	T kit (Terminal box) Single wiring
S1	S kit Double wiring
S2	S kit Single wiring
L0□	L0 kit □: Stations (1 to 12)
L1□	L1 kit □: Stations (1 to 12)
L2□	L2 kit □: Stations (1 to 12)
C	C kit (Plug lead type)

03	Rc 3/8
04	Rc 1/2
B	Bottom ported Rc 1/2

Port size

Note 1) Tie-rods (2 pcs.) and lead wire assembly for station addition included.
Note 2) Splashproof specifications is not available for F and T1.

<Manifold Block Replacement Parts>

Replacement Parts

No.	Part no.	Description	Material	Number
④	VVQ5000-80A-1	Gasket	NBR	10
⑤	VVQ5000-80A-2	Gasket	NBR	10

Note) Spare parts consist of sets containing 10 pcs. each.

<SI Unit>

SI Unit Part No.

Type	Model symbol	SI unit part no.		Description
		For U side mounting	For D side mounting	
Dedicated output model	A	EX323U-S001	EX323D-S001	General type SI unit (Series EX300)
	B	EX123U-SMB1	EX123D-SMB1	Mitsubishi Electric Corporation: MELSECNET/MINI-S3 Data Link System
	BB	EX124U-SMB1	EX124D-SMB1	Mitsubishi Electric Corporation: MELSECNET/MINI-S3 Data Link System (2 power supply systems)
	C	EX123U-STA1	EX123D-STA1	OMRON: SYSBUS Wire System
	D	EX123U-SSH1	EX123D-SSH1	SHARP: Satellite I/O Link System
	F1	EX123U-SUW1	EX123D-SUW1	NKE: Uni-wire System (16 output points)
	H	EX123U-SUH1	EX123D-SUH1	NKE: Uni-wire H System
	J1	EX123U-SSL1	EX123D-SSL1	SUNX: S-LINK System (16 point outputs)
	J2	EX123U-SSL2	EX123D-SSL2	SUNX Corporation: S-LINK System (8 output points)
	K	EX123U-SFU1	EX123D-SFU1	Fuji Electric Co.: T-LINK Mini System
	Q	EX124U-SDN1	EX124D-SDN1	OMRON Corp.: DeviceNet, CompoBus/D (2 power supply systems)
	R1	EX124U-SCS1	EX124D-SCS1	OMRON Corp.: CompoBus/S (16 output points, 2 power supply systems)
	R2	EX124U-SCS2	EX124D-SCS2	OMRON Corp.: CompoBus/S (8 output points, 2 power supply systems)
	U	EX124U-SJN1	EX124D-SJN1	JEMANET (2 power supply systems)
	V	EX124U-SMJ1	EX124D-SMJ1	Mitsubishi Electric Corporation: CC-Link System (2 power supply systems)
G	EX124U-SAB1	EX124D-SAB1	Allen-Bradley Remote I/O (RIO) System (2 power supply systems) (Rockwell Automation, Inc.)	

VQC

SQ

VQ0

VQ4

VQ5

VQZ

VQD